



2023 USPKS Rule Book

Table of Contents:

100 Basic Rules, Safety, Driver Info & Officials:

101 Basics:

- 101.1 Know the Rules
- 101.2 Responsibilities
- 101.3 Supplemental Rules
- 101.4 Drivers Meeting
- 101.5 Podium Pictures
- 101.6 Sponsor Decals
- 101.7 Competitive Series Decals
- 101.8 Spirit and Intent
- 101.9 Social Media
- 101.10 Liability
- 101.11 Pit Pass
- 101.12 Insufficient Funds
- 101.13 Alcohol
- 101.14 Threatening Actions
- 101.15 Driver Penalties
- 101.16 Protest
- 101.17 Review of Go-Pro/Video
- 101.18 Probation
- 101.19 Suspension
 - 101.19.1 Appeal
- 101.20 Registration Packet
- 101.21 Transponder Rental
- 101.22 Sponsor Pit Spots
- 101.23 Vendors

102 Safety:

- 102.1 Helmet
 - 102.1.1 Helmet Out of Compliance
 - 102.1.2 Helmet Cameras
- 102.2 Neck Collar
 - 102.2.1 Neck Collar Out of Compliance
- 102.3 Chest Protectors**
 - 102.3.1 Chest Protector Out of Compliance
- 102.4 Driver Attire
- 102.5 Cameras
- 102.6 Pre-Practice/Race Inspection
 - 102.6.1 Pre-Tech Sheet Penalty
- 102.7 Weight**
 - 102.7.1 Loss of Weight on Track**
- 102.8 Fire Extinguisher

103 Driver Information:

- 103.1 Basic
- 103.2 Minors
- 103.3 Competition Age
- 103.4 Move up Rule
 - 103.4.1 Competitor Over Class Weight
 - 103.4.1.1 Swift Class Competitor
 - 103.4.1.2 Jr or Sr Class Competitor
 - 103.4.2 Competitive Driver Move Up
 - 103.4.3 Class Full Move Up
- 103.5 Relief Driver

104 Race Officials:

- 104.1 Series Director
- 104.2 Race Director
- 104.3 Assistant Race Director
- 104.4 Flagman
- 104.5 Chief Scorer
- 104.6 Grid Steward
- 104.7 Driver's Steward
- 104.8 Tech Director



2023 USPKS Rule Book

200 Chassis/Kart, Tires, Fuel & Oil:

201 Chassis/Kart:

- 201.1 Adjustments
- 201.2 Frame
- 201.3 Floor Pan
- 201.4 Steering
- 201.5 Axle
- 201.6 Brakes
 - 201.6.1 Shifter Brakes
- 201.7 Seat
- 201.8 Suspension
- 201.9 Wheel Hubs
- 201.10 Spindles
- 201.11 Wheel Bearings
- 201.12 Wheels
 - 201.12.1 Wheel Weights
- 201.13 Throttle Pedal Spring
- 201.14 Fuel System
 - 201.14.1 Fuel Line
- 201.15 Chain
 - 201.15.1 Chain Guard
 - 201.15.2 Shifter Chain Guard
- 201.16 Bodywork Components
- 201.17 Front Bumper
 - 201.17.1 Front Bumper Support
- 201.18 Nose Cone
 - 201.18.1 Push Back Nose Cone Mounts
- 201.19 Side Pods and Nerf Bars
- 201.20 Driver Fairing
- 201.21 Rear Bumper
- 201.22 Numbers
 - 201.22.1 Kart Numbering by Class
- 201.23 Rear View Mirrors

201.24 Transponder Mounting

201.24.1 Transponder Mounting Penalty:

201.25 Chassis/Kart Change

201.26 Kart Dimensions

201.26.1 Minimum & Maximum

Rear Wheel/Tire Width

202 Tires & Fuel:

202.1 Tires (Slicks)

202.2 Rain Tires

202.3 Tire Scanning

202.3.1 Rain Tire Scanning

202.4 Spec Fuel

202.5 Spec 2 Cycle Oil

300 Race Information:

301 Flags:

301.1 Green Flag

301.2 Yellow Flag

301.3 Red Flag

301.4 Crossed Flags

301.5 Two Rolled Flags

301.6 White Flag

301.7 Checkered Flag

301.8 Waving Checkered with Red

301.9 Black Flag

301.10 Black Flag with Orange Circle

301.11 Blue/Blue with Yellow Diagonal Stripe Flag



2023 USPKS Rule Book

302 From Grid to Tech:

- 302.1 Communication
- 302.3 Track Layout
- 302.4 Number of Karts Allowed on Track
 - 302.4.1 Number of Karts Required for Class
- 302.5 Quiet Grid
- 302.6 Push Back Nose Inspection
- 302.7 Bumper to Nose Cone Clearance
- 302.8 Pre-Grid
- 302.9 Controlled Grid
- 302.10 Grid
 - 302.10.1 Working on the Grid
- 302.11 Entering the Track for Qualifying
- 302.12 Race Day 90 Second Rule
- 302.13 Driver Unable to Start
- 302.14 Penalties**
 - 302.14.1 Unsportsmanlike or Unsafe Driving**
 - 302.14.2 Avoidable Contact**
 - 302.14.3 Rough Driving**
 - 302.14.4 Forcing Air into the Air Box**
 - 302.14.5 Passing After Checkered Flag**
 - 302.14.1 Push Back Nose Cone Penalties**
- 302.15 Practice
- 302.16 Lapped Competitor
- 302.17 Slowing or Stopping on Track
- 302.18 Exiting Your Kart on Track
- 302.19 Re-entering the Racing Surface
- 302.20 Restarting Engine
- 302.21 No Passing Area (Waving Yellow)
- 302.22 Karts/Drivers Involved in Red Flag
- 302.23 Restarts
- 302.24 Loose or Missing Components
 - 302.24.1 Losing Fluid on Track:
- 302.25 Slick or Rain Tire Condition
 - 302.25.1 Reducing Race Length (In wet)
- 302.26 Exiting the Race Track
- 302.27 Completed Race
- 302.28 Incomplete Race
- 302.29 Combining Classes
- 302.30 Event Format
- 302.31 Qualifying
 - 302.31.1 Qualifying Tie Breaker
- 302.32 Heat Races
- 302.33 Finals
- 302.34 Clearing the Scale
 - 302.34.1 Driving on the Scale
 - 302.34.2 Drinking Fluids Before Clearing the Scales
- 302.35 Data Acquisition
- 302.36 Reporting to Tech
 - 302.36.1 Tech Area
 - 302.36.2 Failure to Report to Tech
 - 302.36.3 Refusal of Tech
- 302.37 Impound Parts or Equipment
- 302.38 Race Starts**
 - 302.38.1 Shifter Starting Procedure**
 - 302.38.2 Shifter Lane Selection**



2023 USPKS Rule Book

303 Race Format, Scoring

& Points:

- 303.1 Race Format
- 303.2 Scoring
 - 303.2.1 Scoring Protests
 - 303.2.2 Scoring Abbreviations
 - 303.2.3 Penalized Starting Positions
 - 303.2.4 Unforeseen Circumstance
- 303.3 Championship Points
 - 303.3.1 USPKS Points
 - 303.3.2 Points Breakdown
 - 303.3.2.1 Qualifying Points
 - 303.3.2.2 Heat Race Points
 - 303.3.2.3 Final Race Points
- 303.4 Tie Breaker
- 303.5 Year End Awards

400 Series Class

Structure:

401 USPKS Class Structure:

- 401.1 IAME Micro Swift
- 401.2 IAME Mini Swift
- 401.3 IAME KA100 Junior
- 401.4 IAME X30 Junior
- 401.5 IAME KA100 Senior
- 401.6 IAME X30 Pro
- 401.7 IAME KA100 Masters
- 401.8 Pro Shifter

500 Engine Rules:

501 General Engine Rules:

- 501.1 Comparison of Know Stock Part
- 501.2 Engine Pressure/Vacuum Testing

- 501.3 Carburetor Return Spring
- 501.4 Clutches
- 501.5 Engine Sealing
 - 501.5.1 KZ Engine Sealing
 - 501.5.2 Engine Seal Penalty
 - 501.5.3 Tampering with Engine Seal
- 501.6 Engine Change
- 501.7 Engine Components
 - 501.7.1 Loose or Missing Engine Components:
- 501.8 IAME Engine Claiming
- 501.9 Cylinder Ports
- 501.10 Starter Batteries
 - 501.10.1 Mounting Batteries
 - 501.10.2 Loss of Battery on Track
- 501.11 Technical Tools
- 501.12 No Go Gauges
 - 501.12.1 Using No Go Gauges
 - 501.12.2 Cord Width No Go Gauges
- 501.13 IAME Supplied Tech Tools
 - 501.13.1 Head & Header Profile Gauges
- 501.14 Piston Squish
 - 501.14.1 Checking Piston Squish
- 501.15 LAD Port Gauge
 - 501.15.1 Checking Exhaust Port Height (LAD Tool)
 - 501.15.2 Checking Exhaust Port Height (Light Check)
 - 501.15.3 Checking Inlet Port Height
 - 501.15.4 Checking Transfer Port Heights (Blowdown)
- 501.16 LAD CC Measuring Plug
 - 501.16.1 KZ CC Measuring Plug:
 - 501.16.2 Cylinder Head Volume/CC Fluid
 - 501.16.3 Burette
 - 501.16.4 CC Procedure



2023 USPKS Rule Book

503 IAME Bambino M1 Rules and Regulations:

- 503.1 Engine
 - 503.1.1 Engine Shroud
 - 503.1.2 Tape on Engine Shroud
- 503.2 Carburetor
- 503.3 Fuel Filter
- 503.4 Air Filter & Cover
- 503.5 Spark Plug
 - 503.5.1 Spark Plug Boot
- 503.6 Muffler
 - 503.6.1 Exhaust Manifold
- 503.7 Clutch
 - 503.7.1 Clutch Test Procedure
- 503.8 Recoil/External Starter
- 503.9 Timing Procedure

504 IAME Swift Rules and Regulations:

- 504.1 Carburetor
 - 504.1.1 Carburetor and Manifold Gaskets
 - 504.1.2 Carburetor Gaskets and Diaphragms:
- 504.2 Fuel Filter
- 504.3 Air Box and Filter
- 504.4 Spark Plug
 - 504.4.1 Spark Plug Boot
- 504.5 Bearings, Seals, O-Rings and Gaskets
 - 504.5.1 Base Gasket
 - 504.5.2 Head Gasket
- 504.6 Piston and Ring
- 504.7 Mini Swift Exhaust Header
 - 504.7.1 Micro Swift Exhaust Header
- 504.8 Exhaust Pipe
- 504.9 Clutch
 - 504.9.1 Clutch Test Procedure:

- 504.10 IAME Swift Spec
- 504.11 Swift Carb Spec HW-31A
- 504.12 Sealing the Swift Engine

505 IAME KA100 Rules and Regulations:

- 505.1 Air Box
- 505.2 Fuel Filter
- 505.3 Carburetor
 - 505.3.1 Carburetor Gaskets and Diaphragms:
- 505.4 Reed Cage
- 505.5 Spark Plug
 - 505.5.1 Spark Plug Boot
- 505.6 Cylinder Head
 - 505.6.1 Cylinder Head O-Ring or Gasket
- 505.7 Cylinder
 - 505.7.1 Base Gaskets
- 505.8 Bearings, Seals, O-Rings and Gaskets
- 505.9 Crankcase
- 505.10 Crankshaft and Rod
- 505.11 Piston and Ring
- 505.12 Ignition
 - 505.12.1 Ignition Ground Strap
- 505.13 Exhaust Header and Pipe
 - 505.13.1 Junior Exhaust Header
- 505.14 Starter & Battery
- 505.15 Clutch
 - 505.15.1 Clutch Test Procedure
- 505.16 Timing Procedure
- 505.17 IAME KA100 Spec
- 505.18 KA100 Carb Spec HW-33A
- 505.19 Sealing the KA100
 - 505.19.1 Sealing the IAME KA100 Senior and Masters Engine:



2023 USPKS Rule Book

506 IAME X30 Rules and

Regulations:

- 506.1 Air Box
- 506.2 Fuel Filter
- 506.3 Carburetor
 - 506.3.1 Carburetor Gaskets and Diaphragms
- 506.4 Reed Cage
- 506.5 Spark Plug
 - 506.5.1 Spark Plug Boot
- 506.6 Cylinder Head
 - 506.6.1 Cylinder Head Gasket
- 506.7 Cylinder
 - 506.7.1 Cylinder Base Gasket
- 506.8 Crankcase
- 506.9 Crankshaft and Rod
- 506.10 Piston and Rings
- 506.11 Bearings, Seals, O-Rings and Gaskets
- 506.12 Ignition
 - 506.12.1 Stator
 - 506.12.2 Ignition Rotor & Key:
 - 506.12.3 Ignition Timing Procedure:
- 506.13 Exhaust Header, Connector / Flex and Pipe
 - 506.13.1 Junior Exhaust Header
- 506.14 Radiator
- 506.15 Water and Coolants
- 506.16 Clutch
 - 506.16.1 Clutch Test Procedure:
- 506.17 IAME X30 Spec
- 506.18 X30 Carb Spec HW-27A
- 506.19 Sealing the X30 Junior Pro Engine
- 506.19.1 Sealing the IAME X30 Senior Pro Engine:

507 ~~IAME SSE &~~ KZ Rules and

Regulations:

- 507.1 Homologation
- 507.2 Basic Engine
- 507.3 Modifications
- 507.4 Carburetor
- 507.5 Silencer/Air Box
- 507.6 Ignition
- 507.7 Exhaust
- 507.8 Exhaust Silencer
- 507.9 KV Spec
- 507.10 Sealing the ~~SSE~~ and KZ
- 507.11 Radiator



2023 USPKS Rule Book

100 Basic Rules, Safety, Driver Info & Officials:

101 Basics:

*** Note: The Series reserves the right to modify any rule, at any time, to ensure program safety and fairness.**

101.1 Know the Rules:

By participating in this league, USPKS participants agree to take on the responsibility of knowing, and following, the rules set forth in this document, and agree to always hold safety, fairness, and sportsmanship in the highest regard.

101.2 Responsibilities:

The driver or guardian of each kart is responsible for the safe operation and condition of the equipment. Further, drivers and guardians are not only responsible for their actions, but also the actions of any crew member, family or friend while participating in a USPKS event.

101.3 Supplemental Rules:

The Race Director can implement supplemental rules at any event. Supplemental rules will take precedence over any written rule. Any supplemental rule will be delivered to the competitors in written form, or verbal form if necessary.

101.4 Drivers Meeting:

Every competitor is required to attend the drivers meeting; all minors must have a parent or adult representative in attendance also. If a competitor does not attend the meeting, he/she loses the right to protest and will receive a two (2) position penalty added on to their qualifying spot for event. Example: if you qualify 3rd, you will be starting 5th in all races that use your qualifying position as the lineup. A roll call may or may not be called at the Race Director's discretion.

101.5 Podium Pictures:

All drivers are required to wear their driver's suit and bring their helmet during podium pictures.

101.6 Sponsor Decals:

All karts must have all official Sponsor decals for their class on the kart, in the correct position per provided diagram (in registration packet). If appropriate decals are not on the kart or in the correct position, the offending competitor may be warned during qualifying or heats. If the competitor does not have the sponsor decals on after the final, they will be penalized one position per decal that is missing or out of place.

101.7 Competitive Series Decals:

Competitive series decals are not allowed and must be removed before competing in a USPKS event. A competitor may be warned to remove any competitive series decal on their kart during qualifying or heats. If the competitive series decal remains after the final race, the offending competitor will be penalized one position per decal.



2023 USPKS Rule Book

101.8 Spirit and Intent:

Karting should be fun for everyone. The less that we have to officiate the better the event will become. Officials, teams, drivers, and families should treat each other with respect. Any lack of clarity within the rules does not provide the legality of an entrant. USPKS has the right to prevent any competitor from participating in the event, as well as disqualify them from any sessions for not being compliant with and/or attempting to circumvent the rules or the spirit of the rules.

101.9 Social Media:

When differences of opinion arise regarding USPKS rules and regulations, decisions by USPKS officials, USPKS policies, or between the competitors (and/or their charges), communication and discussion of these differences are best handled privately and directly between the parties involved. We ask all competitors to refrain from unsportsmanlike social media attacks, and to settle all disputes professionally and privately. Harmful and egregious social media postings may subject a competitor to discipline, including probation or suspension.

101.10 Liability:

All participants must sign a waiver/pit pass releasing USPKS and officials of liability before participating in a USPKS event. The signee agrees to hold USPKS and officials harmless from any and all liability. This includes but is not limited to: injury to person, employees, property and/or reputation that may be sustained by signee, from all claims of injuries at present and future. This includes minors that may be at a USPKS event.

101.11 Pit Pass:

All individuals intending to enter the pit area are required to purchase and wear a pit pass at all USPKS events

101.12 Insufficient Funds:

Failure to pay dues and costs may result in suspension until payment is complete. For repeat offenders, USPKS may require future payments be made via cash, money order, or certified check indefinitely.

101.13 Alcohol:

Alcohol is strictly prohibited for all competitors, crew members, family members, friends, spectators, participants in any capacity at all times during the day's racing event.

101.14 Threatening Actions:

Competitors are prohibited from verbally threatening, physically intimidating, or otherwise insulting any fellow competitor, official, crew members, participating, or spectator, both during and outside any USPKS event. Any competitor found in violation of this rule will be subject to discipline pursuant to the guidelines described herein.

101.15 Driver Penalties:

Competitors will be penalized in portion to their offense. Examples of penalties include, but are not limited to, loss of position, start at the rear of the field, disqualification, probation or suspension as described herein.



2023 USPKS Rule Book

101.16 Protest:

It is USPKS's intent to make every effort to resolve all protests on the track before an event concludes. All on track penalties will be decided at the event.

On-Track Officials are unavailable to review or discuss penalties until racing is completed for the day.

Competitors wishing to obtain more information about a penalty or file a protest should see the Driver's Steward, who is based in the scale/tech area.

Verbal protests will not be accepted, and Protests cannot be submitted for non-performance items.

Only 1 protest per event, per driver

There will be a \$200.00 deposit for each protest, to be refunded if competitor successfully protests their penalty.

Any protest of technical specification legality and driver conduct must be submitted in writing by a legal entrant from the same class in which the alleged violation occurred.

If a kart specification is protested, the protesting driver's own kart can also be subject to full inspection. If an engine specification is protested, the protesting driver's engine can also be subject to full inspection.

The protest must be submitted in writing within 30 minutes after the technical decision has been made by an official. Once a competitor's equipment has been removed from the impound area, he or she has waived the right to file a protest.

All protests must be submitted in writing to the Tech Director or Driver's Steward of the USPKS or sanctioned event within 30 minutes after the class or race that is being protested clears the scale, or in the case of a scoring protest, 30 minutes after official results have been announced or posted.

All protests must refer to a specific USPKS rule.

Anyone filing a protest on another competitor's equipment must keep his or her own equipment in the impound area following the race until the protest has been resolved.

Once a competitor's equipment has been removed from the impound area, the competitor immediately waives the

right to file a protest on another competitor's equipment, even if they are within the otherwise valid 30-minute protest window. If a driver's finishing position is adversely affected by an incident on the track, the driver cannot be reinstated to his or her previous position. However, this does not prevent the driver from filing a protest after the race to argue a position penalty given by the officials. Go-Pro/Video must be submitted within the 30-minute limit and must have a tablet or laptop available for viewing. (See 101.17)

101.17 Review of Go-Pro/Video:

In the event of a protest, the USPKS Race Director (or designated official), may choose to review video evidence a competitor makes available. A protest shall be filed and the competitor-produced video must be immediately available for the official to review on a tablet or laptop (Phone or Go-Pro will not be permitted), if the Race Director deems it necessary. The Race Director maintains absolute discretion when evaluating video evidence.

***It is up to the competitor to obtain the video or videos for review.**

101.18 Probation:

USPKS officials may place a driver, participant, or spectator on probation for a set amount of time or races as determined by USPKS. Probation is formal USPKS designation – and any individual placed on probation will be notified in writing. Probation is reserved for serious offenses that threaten the health and safety of our drivers, participants, or spectators, or impact the fair and competitive balance of our league. USPKS reserves the right, in its sole discretion, to determine what offenses warrant probation.

While under probation, an individual's actions are subject to stricter scrutiny. Specifically, if any individual under probation repeats the same offense, commits a similarly egregious offense, or otherwise violates USPKS rules with impunity, that individual will be automatically placed under suspension pending appeal. See 101.18 Suspension.



2023 USPKS Rule Book

101.19 Suspension:

USPKS officials can suspend a driver, participant, or spectator for a set amount of time/races as determined by USPKS. Suspension is formal USPKS designation – and any individual who is suspended will be notified in writing. Suspension is reserved for repeat offenses worthy of probation under USPKS Rule 101.17 Probation. In extreme circumstances, for offenses so egregious or unwarranted – an individual may be suspended without a probationary period altogether. USPKS reserves the right, in its sole discretion, to place any individual on suspension for any act it deems sufficiently egregious. While under suspension, an individual is barred from attending – in any capacity – any USPKS official event.

101.19.1 Appeal:

USPKS ensures all its competitors a fair and just appeals process. Accordingly, all suspensions, but not probation, will be stayed for the duration of any formal appeal, not to exceed ten (10) days. To initiate a formal appeal, individuals must contact USPKS at mcoats.uspks@gmail.com within forty-eight (48) hours of their formal suspension notification, and state the general basis for their appeal. At that time, USPKS will make a determination of what is required to effectuate a fair and just appeal, and notify the individual accordingly. This may include, but is not limited to, an in-person hearing, a virtual hearing, a formal written letter, or a conference call with USPKS officials. After appeal, USPKS decisions are final, and will be posted publicly.

101.20 Registration Packet:

Each driver or guardian shall pick up the registration packet from the USPKS trailer or designated area. The registration packet will contain information required.

101.21 Transponder Rental:

If a competitor does not have their own working transponder, they must rent one on the day of the event. USPKS has a limited number of rental transponders available at the Series Trailer. If the rented transponder is not returned at the conclusion of the event, the competitor will be charged \$500.00 for the cost of the unit.

101.22 Sponsor Pit Spots:

Sponsors of the series will receive premier pit spots over non-sponsor participants provided the sponsor contacts the person in charge of the pit spots for each event before the deadline.

101.23 Vendors:

Vendors that are sponsors of the Series will be permitted to sell supplies at USPKS events as part of the sponsorship package. Vendors that are not sponsors of the Series shall obtain permission to sell supplies and will be charged a fee of \$500.00 per event.



2023 USPKS Rule Book

102 Safety:

* Safety attire or equipment including kart can be inspected at any time.

* Any safety violation could result in a penalty or DQ.

102.1 Helmet:

Full face helmets with shields attached are mandatory and shall meet one of the following requirements:

FIA Helmets	Expiration Date
FIA 8859-2015	10 years from manufacture date if it is in helmet, if date is not in helmet, it expires 10 years after spec
FIA 8860-2010	
FIA 8860-2018	
FIA 8860-2018 ABP	
Snell Foundation Specifications	Expiration Date
M or SA 2015	12/31/2025
CMR or CMS 2016 (Youth)	12/31/2026
K, M or SA 2020	12/31/2030
SFI Specifications	Expiration Date
41.1/2013	12/31/2023
24.1/2015 (Youth)	12/31/2025
31.1 or 41.1/2015	12/31/2025
24.1/2020 (Youth)	12/31/2030
31.1 or 41.1/2020	12/31/2030
24.1/2021 (Youth)	12/31/2031

The Snell Foundation or SFI sticker must be inside of the helmet. If the manufactures date is inside the helmet, we will use that date. If the date is not in the helmet, we will use the specification sticker. The helmet will expire at the end of the year 10 years after the manufactures date.

Helmet shall be in good condition with no visible signs of damage and shall be the correct size for the driver per manufacturer's specifications, so it will not come off the driver's head or impair the vision of the driver by moving around. Helmets shall be inspected during pre-race inspection and a safety sticker placed on the helmet once it has been approved. Helmet can also be inspected at any time if it is subjected to damage during an incident on or off the track. If driver has hair that could extend past the shoulders, they shall wear a head sock and tuck hair inside driver suit or jacket to prevent it from getting tangled in any moving parts.

102.1.1 Helmet Out of Compliance:

Any driver that is found out of compliance in a post-race inspection with the rule and specifications listed under 102.1 will receive a 10-position penalty.

102.1.2 Helmet Cameras:

Cameras **SHALL NOT** be mounted on or inside the helmet in any way, unless it is embedded in helmet during the manufacturing process.

102.2 Neck Collar:

All classes except Senior/Masters must wear a Neck Collar as manufactured and shall not be altered in any way. If a driver does not have a neck collar on, loses their neck collar or it becomes loose while on track, they will be black flagged immediately.

Senior/Master classes do **NOT** require a neck collar.

Advanced neck and head support are highly recommended for drivers of all ages.

Approved Advanced Neck and Head devices include:

- Leatt-Brace Moto Kart and Moto GPX
- EVS Evolution Race Collar
- Valhalla 360 Plus Device

2023 USPKS Rule Book

102.2.1 Neck Collar Out of Compliance:

Any driver that is found out of compliance in a post-race inspection with rule listed above will be disqualified for that race.



102.3 Chest Protectors:

All drivers under the age of 13 years in all divisions are required to wear a chest protection device with **SFI approved specification 20.1** at all times they are on the race track. **The SFI tag must be attached to the chest protector. The following chest protectors are approved and certified by SFI.**

RECOMMENDED: The use of chest protection is recommended for all types and ages of kart drivers.

Group 6

3590 Pebble Beach Dr., Martinez, GA 30907

706-373-4515 www.group6gear.com 20.1/1, 20.1/2



The chest pad Shall be in place while on track.

Ribtect

102 Holly Oak Court, Victoria, TX, 77901

(310) 487-8938 www.ribtect.com 20.1/1, 20.1/2



The Ribtect Chest Protector. Designed for maximum protection and comfort.

Team Valhalla

22227 F50, Stryker, OH, 43557

(419) 682-1360 www.valhallaracing.com 20.1/1, 20.1/2

The following FIA approved chest protectors are also legal.

Bengio AB7 with chest protector



OMP KS-1 Pro with chest protector



Stilo Carbon Curva 8870 Karting Body Protection



Tillett P1 Defender with chest protector





2023 USPKS Rule Book

102.3.1 Chest Protector Out of

Compliance:

Any driver that is found out of compliance in a post-race inspection with rule 102.3 will be disqualified for that race.

102.4 Driver Attire:

Drivers shall wear ballistic nylon, leather, vinyl or other abrasion resistant jackets with full length pants, gloves, closed toe shoes and socks to limit the chance of abrasion. Sweatpants do not provide adequate protection. Hooded sweatshirts, bandanas or long belts that could become tangled in moving parts are not allowed.

102.5 Cameras:

Camera should not obstruct the driver's vision or block the view of the number panel in any way. Cameras may be mounted on kart as long as it will bend or break away if hit by another object such as a driver or body part. It is highly recommended that your kart number be clearly marked on your camera.

102.6 Pre-Practice/Race Inspection:

A Pre-Tech sheet will be included in the registration packet. This sheet shall be filled out completely with initials in all applicable boxes, N/A if not applicable. The Pre-Tech form shall be submitted to the Tech official along with your Kart, Helmet, Chest Protector (if applicable) and Race Tires to receive the chassis band before entering the track. Race Tires (slicks) can be scanned later but must be scanned by the time listed on the Timeline. Only one Pre-Tech sheet per kart, per event will need to be filled out unless competitor changes chassis (see Chassis/Kart Change 201.25). All karts shall be inspected and have a chassis band attached after passing inspection and before it will be allowed on the track for practice or racing. Helmets must be inspected and have USPKS safety sticker applied before entering the track.

102.6.1 Pre-Tech Sheet Penalty:

If a postrace inspection is performed on a competitor's kart and infractions are noted the following penalties will be handed out.

- 1 issue = warning
- 2 – 3 issues = 1 position penalty
- 4 – 5 issues = 2 position penalty
- 6 or more issues = 3 position penalty

102.7 Weight:

Weight that is added to the kart to achieve minimum weight for the class shall be white in color, this does not mean white tape with other colors or printing on it, package tape will not be acceptable. All weight shall have the competitor's number on the weight. Weight up to and including six (6) pounds shall be bolted on with a minimum 5/16" (8mm) diameter bolt. The bolt shall be double-nutted or have safety wire or a cotter pin inserted through a hole drilled in the bolt to prevent the nut from coming off. Weight over six (6) pounds shall have at least two 5/16" (8mm) or larger bolts, affixing the weight to the kart, **this includes stacking weight on top of each other that totals more than six (6) pounds.** The bolts shall be double-nutted or have safety wire or a cotter pin inserted through a hole drilled in the bolt to prevent the nut from coming off. Mounting weight to bumpers, nerf bars, side pods or any component that is not secure shall not be allowed. Driver is not allowed to have any type of additional weight added to their safety attire or body such as exercise weight straps or weight in pockets.

102.7.1 Loss of Weight on Track:

Any competitor losing weight while on track will receive the follow penalty:

- 1) **During practice, loses next round of practice**
- 2) **Last round of practice, loses fastest lap of qualifying**
- 3) **During qualifying, heat or final, is DQ**



2023 USPKS Rule Book

102.8 Fire Extinguisher:

It is highly recommended that each entrant in the event have a minimum of one operable 1-1/2 pound dry-powder fire extinguisher (rated for use on A, B, & C type fires) in their pit area. It is recommended that they have one on the starting grid at the start of each race in the hot pit area. Carbon Dioxide type extinguishers are not acceptable substitutes for the dry-powder type.

103 Driver Information:

103.1 Basic:

Drivers must be in good standing with USPKS. Driver must not be under the influence of alcohol or controlled substance. Drivers shall be entered in the correct class for their age, as most of the classes have a minimum and/or maximum age limit (see class rules).

103.2 Minors:

It is mandatory that drivers under the age of 18 submit a minor's release form signed by the legal guardian at each event. If the parent or legal guardian is not present at the event, the minor's release **MUST BE NOTARIZED**. Proof of age is also required. This can be a birth certificate, passport, driver's license, or any official document verifying the minor's age. A record of the verification will be kept by the Series. The Series will not retain any copies of these documents. This proof of age is only required once a year **IF** the Series does not already have a record on file.

103.3 Competition Age:

The Competition Age of a driver is determined by the driver's actual age at the start of the calendar year (Jan 1st). Any driver meeting the minimum age requirement to move up to the next level by the end of the calendar year is eligible to do so anytime during the year. However, once they compete at the higher level,

they may not move back to the lower level. EXAMPLE: If a driver is 14 on Jan 1st but will be 15 in July, he/she may stay in Junior or move up to Senior Pro (USPKS). Falsification of age will lead to disqualification and/or suspension. ** USPKS has the right to refuse a driver wishing to move up to the next level if they feel it is for the best interest of the driver or Series.

103.4 Move up Rule:

A competitor is not allowed to move up from one age group to a higher level, and then back down. Once a competitor moves up, they must stay in that class unless USPKS feels it is not in the best interest of the Series.

103.4.1 Competitor Over Class Weight:

103.4.1.1 Swift Class Competitor:

Competitors that are 10 lbs. or more over the class minimum weight, with no ballast on kart; may request permission from the Tech Director to move up to the appropriate Class providing the following:

- 1) They must have lap times competitive for the Class that they are moving to.
- 2) They must present the kart race ready, with the driver's safety gear in the seat, to the Tech Director to verify the weight of the kart and driver.

*They will be subject to a weigh-in at any time.



2023 USPKS Rule Book

103.4.1.2 Jr or Sr Class Competitor:

Competitors that are 20 lbs. or more over the class minimum weight, with no ballast on kart; may request permission from the Tech Director to move up to the appropriate Class providing the following:

- 1) They must have lap times competitive for the Class that they are moving to.
- 2) They must present the kart race ready, with the driver's safety gear in the seat, to the Tech Director to verify the weight of the kart and driver

*They will be subject to a weigh-in at any time.

103.4.2 Competitive Driver Move Up:

Drivers with extensive experience that wish to move up to the next age group, may petition the Series to be considered for an exemption.

Drivers must meet both requirements below to be considered, and submit an Age Waiver Form, (obtained from the Series Administrator).

- 1) Driver must be within 3 months of otherwise being of legal age to compete in that class. In other words, their birthday must be before the end of March, the following year.
- 2) Driver must be a past champion or runner up in a major National or International series with at least 20 competitors in the class. USPKS, SKUSA Pro Tour, Rok Cup, Rotax, etc.

103.4.3 Class Full Move Up:

Any driver forced to move up to another age level due to the lower age level class being capped, may move back to the lower age level class at a future event with USPKS approval

103.5 Relief Driver:

A relief driver can be utilized after the driver qualifies the kart and becomes unable to compete (due to illness or injury during the event) in the remaining races for that day after approval by USPKS. The relief driver must start at the rear of the field. The relief driver will be allowed to start the final in the spot they achieved from the heats. If the registered driver decides to race after the relief driver has run the heats, they will be required to start in the rear of the field. The use of an unapproved driver will result in disqualification and/or suspension of the driver of record by USPKS.

104 Race Officials:

104.1 Series Director:

Directs event operations, competition, safety, event schedule, and communication. Manages USPKS Race officials.

104.2 Race Director:

Oversees on-track activities, imposes penalties, communicates information to competitors and teams.

104.3 Assistant Race Director:

Works directly with Race Director to assist with on-track activities, determine penalties, and inform competitors of imposed penalties.

104.4 Flagman:

Works with the Race Director and Assistant Race Director to control all on-track activities and gives input on penalties.

104.5 Chief Scorer:

Responsible for timing and scoring, broadcasts to RaceMonitor or Race Hero as applicable, publishes race results to MyLaps, calculates points and posts results.



2023 USPKS Rule Book

104.6 Grid Steward:

In charge of following the published schedule, checks to assure all karts and helmets have been inspected, practice sticker and transponder are on kart, as well as releasing the field to the track when track is clear and ready.

104.7 Driver's Steward:

Is the person to contact if a competitor has a on track issue prior to filing a Protest. The Driver Steward will be in located the Scale or Tech area.

104.8 Tech Director:

In charge of pre-race and post-race inspections for both general safety and compliance with technical rules to ensure safety and fairness.

200 Chassis/Kart, Tires, Fuel & Oil:

201 Chassis/Kart:

*** Note: All measurements are in inches unless otherwise stated.**

*** Note: CIK homologated components shall remain OEM unless specified in the specific component rule.**

201.1 Adjustments:

The only adjustment a driver can make while on the track is the carburetor, brake bias or radiator louvers/shroud. Removing tape from radiator while on track is allowed.

Adjustments must be made manually; mechanical adjustments are illegal.

201.2 Frame:

Main frame shall be round tubing with a minimum diameter of 1.0" and maximum diameter of 1.4". Minimum wall thickness for 1" diameter tubing is .078" and, for 1.125" or greater diameter tubing minimum wall thickness is .060". Frame tubing shall be minimum cold rolled or electric welded tubing or tubing of equivalent strength.

201.3 Floor Pan:

Floor pan is required, must not extend rear of the front seat mount/crossbar, it must be inside the frame rails and securely bolted in place. Must be made of metal, aluminum or composite, no plastic materials are allowed.

201.4 Steering:

Direct mechanical type steering is required; vertical shaft or rack and pinion steering is illegal. Steering shafts shall be attached at bottom with a minimum 5/16" fastener. Minimum diameter for solid steering shaft is 0.625" and for a hollow shaft it is 0.700". Minimum diameter for steering wheel hub bolts is 1/4" grade 5. All tie rod component bolts shall be a minimum of 5/16" grade 5 bolts. Tie rods shall swivel at both ends and be made of steel or aluminum. Steering wheel must be round in shape with a minimum of three spokes and 10" diameter. The top third of the wheel may be flat or open but they must be designed that way and cannot be altered. Shaft adapters that change the angle of the steering wheel are legal. It is highly recommended where possible that steering component bolts are drilled with safety wire/cotter pin inserted, or machined for e-clips with e-clips installed. At minimum lock nuts will be required.

2023 USPKS Rule Book

201.5 Axle:

The axle must be a one-piece axle; it can be solid or tubular with a minimum diameter of 25mm, a maximum diameter of 50mm and a minimum wall thickness of 0.075". Carbon fiber or carbon fiber composite axles are not allowed. Stiffeners are allowed if they are secured with bolts that are drilled for cotter pin or safety wire or machined for spring clips or e-clips; with the above mentioned properly installed (cotter pin, safety wire, or e-clip). Snap ring grooves, or any machining other than for keyway, are not allowed anywhere in the area between the left and right wheel hubs. Axle shall not extend past the outside edge of the wheel. Maximum width of rear track at widest point is 55 1/8".

201.6 Brakes:

Kart shall have rear brakes that shall prevent the wheels from turning when adequate pressure is applied to the brake pedal. Brake pedal and master cylinder must be attached to the main frame with bolts that are drilled with safety wire/cotter pin inserted, or machined for e-clips with e-clips properly installed. It is highly recommended where possible that the brake caliper be attached to the main frame with bolts that are drilled with safety wire/cotter pin inserted, or machined for e-clips with e-clips properly installed. Brake rotor must be attached to the brake hub with a minimum of three bolts that are drilled with safety wire/cotter pin inserted, or machined for e-clips with e-clips properly installed, or steel lock nuts on a minimum of three bolts; nylon lock nuts are not allowed on the brake rotor. The linkage from brake pedal to master cylinder or brake bias must be either 6mm or larger steel rod with clevis or heim joint fittings with jam nuts on each end or kart manufactured cable that is a minimum diameter of 2.5mm. NOTE: If secondary cable is used nylon locknuts may be used in place of drilling or machining bolts for actuating rod and secondary cable. Scrub or band-type brakes are not allowed. Brake components must be steel or aluminum; ceramic, carbon fiber or such materials are

not allowed. Hydraulic connections must be clean and tight with no leaks and routed to prevent damage while operating kart.

Hand brakes are not allowed. An exception may be requested for a driver with a disability and must be approved by USPKS.

201.6.1 Shifter Brakes:

Shifter karts are required to have four-wheel braking with two (2) independent master cylinders

201.7 Seat:

Seat shall be a molded, one-piece sprint bucket design and be the correct size for the driver so they cannot move or slide from side to side in a manner that could be unsafe or to gain an advantage from aerodynamics. Lay down type seats are illegal. Seat cannot be cut in any way to add or remove material and shall be in safe condition, e.g., the bottom is not weak or broken. Bottom of seat shall be between the frame rails and can be mounted above or below the frame rails.

Seat shall be mounted to the kart in a minimum of four spots with front of seat being higher than the bottom.

Adjustable seats that can be moved while on track are illegal. See chart and following

Figure for dimensions. Seat belts or other restraints are illegal.

* Repairing the bottom of the seat from rubbing on the track is allowed.

"A" – Any part of the seat cannot be behind the axle.

"B" – These are minimum measurements.

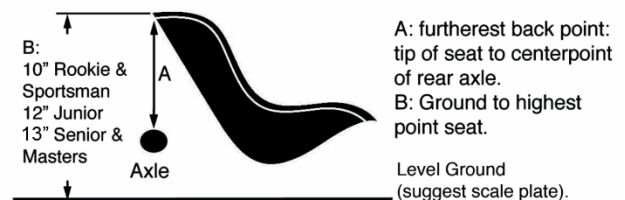

2023 USPKS Rule Book

201.8 Suspension:

Suspension components are not allowed, for example, springs, shocks or other components.

201.9 Wheel Hubs:

Wheel hubs must be made from metallic materials with wheel studs having a minimum diameter of 0.3125".

201.10 Spindles:

Spindle shall not extend past the outside edge of the wheel. It is highly recommended where possible that spindle bolts are drilled with safety wire/cotter pin inserted, or machined for e-clips with e-clips installed. At minimum lock nuts will be required.

201.11 Wheel Bearings:

Split race bearings are not allowed. Bearings must be ground ball or roller bearings. Bearings must be adjusted to remove excessive play.

201.12 Wheels:

Must be 5" diameter, as manufactured (no drilling or removing material) and proven to withstand the force and strain of the racing condition. Lateral supported wheels or g-rings will not be allowed. Maximum width of rear track at widest point is 55 1/8" unless specified under class structure or supplemental rules.

201.12.1 Wheel Weights:

Wheel weights are allowed with each piece not to exceed 1/4 ounce. Placing duct tape over weights to secure is suggested for extra safety.

201.13 Throttle Pedal Spring:

Positive acting throttle pedal return spring is required on all karts.

201.14 Fuel System:

One fuel tank maximum per kart. Fuel tank must be puncture resistant and leak proof when the fill cap is on. Maximum capacity is nine liters. Tank must be within the frame and under the steering shaft, mounted to either the steering uprights or floor pan. Pressurized fuel system or any fuel pumps other than a pulse pump in the carburetor is illegal.

201.14.1 Fuel Line:

All fuel line connections shall be securely attached. It is highly recommended that a cable tie, safety wire or other approved fastener is used. Fuel line shall not be in excessive length or size.

201.15 Chain:

Chain sizes allowed are #219 or #35. Chain oilers are not allowed.

201.15.1 Chain Guard:

All karts are required to have a chain guard. It is recommended that IAME classes use a full chain guard as pictured below.



201.15.2 Shifter Chain Guard:

Shifter class requires a chain cover strap to fully cover the top of the chain from the engine sprocket to the rear axle sprocket.

2023 USPKS Rule Book

201.16 Bodywork Components:

CIK appearing bodies, CIK homologated, and aftermarket bodywork that is made from CIK-similar material are allowed. Bodywork is defined as two side pods, nose cone and driver fairing and all pieces are required in all classes. No bodywork may extend wider than the rear tire/wheel at any time. No part of the bodywork can be used as a fuel tank. No weight or ballast can be placed inside or on the bodywork. Cutting the bodywork for the starter hole and/or radiator in a water cooled class is the only cutting that is allowed. Bodywork must be properly attached and appear neat. Any bodywork that appears loose or that may fall off while on the track could be cause for a black flag.

*** Cadet bodywork including the nose shall be used on Cadet Karts.**

201.17 Front Bumper:

Two steel tubes are required for the front bumper: top tube must be a minimum diameter of 0.625" and attached to the frame at each end, bottom tube must be a minimum diameter of 0.750", both tubes shall have a minimal wall thickness of 0.065" and shall be attached to the frame at each end. Both tubes must be used to attach the nose cone to the kart. If pedals are mounted to the bottom tube it must be welded or through-bolted to the frame.

201.17.1 Front Bumper Support:

Shall be 2 pieces made of plastic and cannot be modified in any way. The measurements below are using CIK Homologation bumpers, top bar is 16mm, bottom bar 20mm. The dimensions below are in mm.

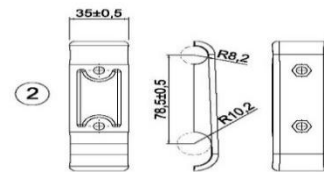

201.18 Nose Cone:

The nose cone shall be mounted with butterfly clamps. If nose cone comes off while on track before receiving checkered flag, competitor will receive the black flag. Nose cones must be used as manufactured and cannot be altered in any way. Bottom of nose shall be a minimum one-half inch ($\frac{1}{2}$ ") off the ground and top of nose shall not be above the top of the front tires. Minimum nose width is $39 \frac{3}{8}$ "; maximum width cannot be wider than the front tires. Maximum overhang from center of front axle to tip of the nose cone is $26 \frac{3}{4}$ ". Measurements will be performed with wheels straight ahead and without driver in kart.*

Cadet nose shall be used on Cadet Karts.

2023 USPKS Rule Book

201.18.1 Push Back Nose Cone Mounts:

All karts shall use the push back nose cone mounts. May be compared to known OEM part in case of discrepancy, dimensions below. The arrow must be pointed upward as pictured below.

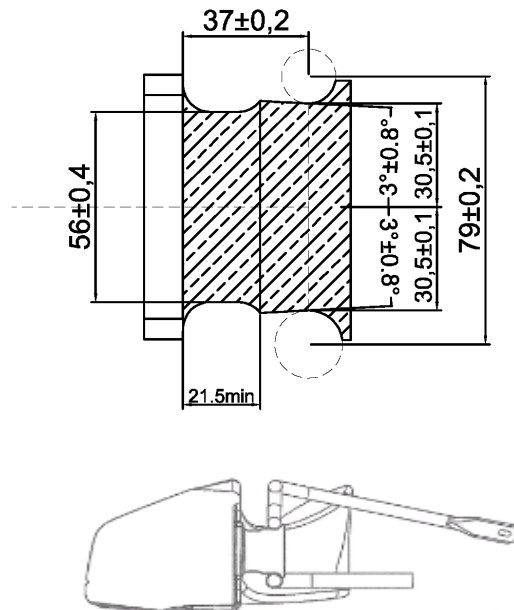

201.19 Side Pods and Nerf Bars:

Side pods must be mounted with the intended manufactured nerf bar for the side pod that is being used. Side pod cannot cover any part of the driver or frame. If side pod comes off while on track, competitor will receive the black flag. Bottom shall be a minimum of 1/2" and maximum of 2 5/8" above the ground, rear shall be no more than 2 5/8" from rear tire, and front shall be no more than 5 7/8" from front tire. Maximum width of side pods is 55 1/8" if the rear track is set at 55 1/8". Measurements will be performed with wheels straight ahead. Nerf bars shall be steel tubing with a minimum diameter of 0.630" and attached to the frame at two (2) points.

*** Side Pods shall not be wider than the rear tires at any time.**

*** Cadet side pods shall be used on Cadet Karts.**

201.20 Driver Fairing:

The driver fairing must be mounted with bendable material that is attached to the uprights, frame or floor pan and cannot expose any sharp edges that could harm the driver. No part of the fairing shall extend more than 1" above the top of the steering wheel. Minimum fairing width is 9 7/8"; maximum width is 11 13/16". Measurements will be performed with wheels straight ahead; height of fairing will be checked on scales. If an official feels that the height of the fairing is hindering the driver's vision, the fairing must be lowered. No part of the driver fairing can be behind and/or lower than the top of the nose cone that could stop the nose cone from being pushed back.

*** Cadet driver fairing shall be used on Cadet Karts.**



2023 USPKS Rule Book

201.21 Rear Bumper:

CIK style PLASTIC rear bumpers are mandatory in all 2 cycle classes. Bumper shall be a minimum of 1" behind rear tire as raced. Adjustable width bumpers are legal. The bumper shall cover at least 50% of each rear tire and shall not extend outside of the rear wheel/tire at any time. The rear bumper must remain as an OEM part; it cannot be cut in any way to narrow or shorten.

*** Cadet bumpers cannot be used on standard karts.**

201.22 Numbers:

All karts shall have legible numbers without tire marks or other items such as decals applied. The number must be black on a yellow background. The numbers must be at least 5 1/2" tall, at least a 3/4" body, and at least 1/2" wide yellow border around each number, Arial Font is suggested. The numbers must be on driver fairing, both side pods and rear bumper prior to entering the track. All karts shall use the number that was assigned to the driver at registration and numbers will consist of one to three digits only. We do not use letters for scoring, they are not acceptable.

*** Anyone not having any of the above could be black flagged during any session.**

201.22.1 Kart Numbering by Class:

All karts will be numbered per class as follows;

IAME Micro Swift	0 – 99
IAME Mini Swift	100 – 199
IAME KA100 Junior	800 – 899
IAME KA100 Senior	900 – 999
IAME X30 Junior	700 – 799
IAME X30 Senior	300 – 399
IAME KA100 Masters	400 – 499
IAME SSE & KZ	200 - 299

201.23 Rear View Mirrors:

Rear view mirrors are not allowed on any karts.

201.24 Transponder Mounting:

The transponder shall be mounted securely and safely to the left side pod of the kart. The transponder must be mounted behind the kingpin using two vertical lines at minimum of 9" from center of king pin to the front edge of the transponder. One transponder per kart is allowed. Transponders are mandatory from the beginning of series-controlled practice through the end of the event.

Transponder must be mounted up and down (so you can read it) with no objects below it i.e., lead.

201.24.1 Transponder Mounting Penalty:

Starting with the second round of the official practice if the transponder is not mounted on the left side pod the competitor will not be allowed on track.

201.25 Chassis/Kart Change:

Changing an un-repairable chassis to a comparable chassis of the same manufacture is allowed after tech approval with no penalty to the competitor. If competitor wants to change chassis due to performance they will start in the rear of the next race. Following approval of the requested chassis change from a Tech Official, a new pre-tech form will need to be obtained from the USPKS Registration Trailer, filled out and then presented with the kart to a USPKS Tech Official for a new chassis band.

2023 USPKS Rule Book

201.26 Kart Dimensions:

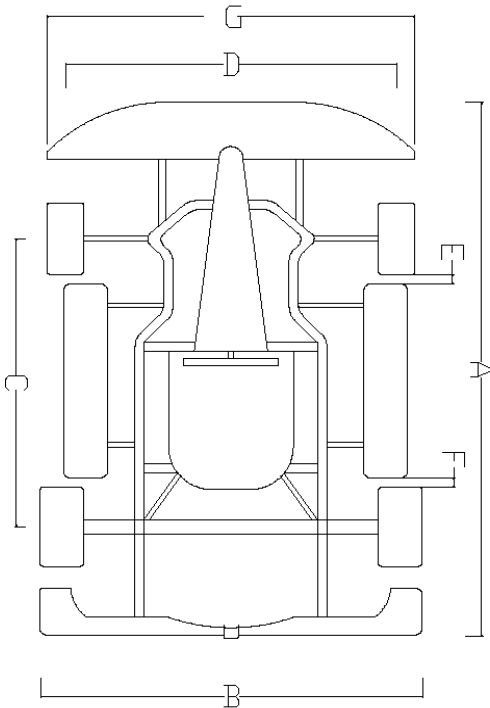

Kart Dimensions		
All Measurement Are Done with Wheels Straight Ahead and No Driver		
Letter	Description	Measurement
A	Cadet Maximum Length	71"
	Standard Maximum Length	82"
B	Maximum Rear Wheel Outside Width	55 1/8"
	Minimum Rear Bumper Width	Cover 50% of both tires
	Maximum Rear Bumper Width	Bumper cannot extend past outside edge of rear tire/wheel
C	Cadet Minimum Wheel Base	35"
	Cadet Maximum Wheel Base	41"
	Standard Minimum Wheel Base	39 3/4"
	Standard Maximum Wheel Base	43"
D	Minimum Front Width Center to Center	28"
E	Maximum Between Front Tire and Side Pod	5 7/8"
F	Maximum Between Rear Tire and Side Pod	2 5/8"
G	Minimum Nose Cone Width	39 3/8"
	Maximum Nose Cone Width	Cannot be wider than outside edge of front tires.

2023 USPKS Rule Book

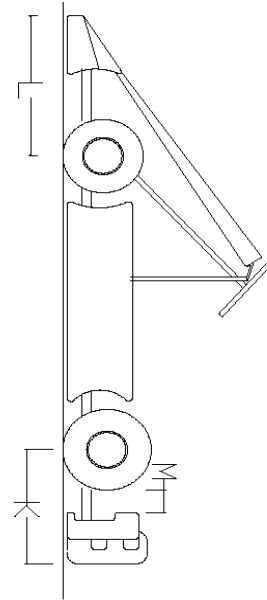
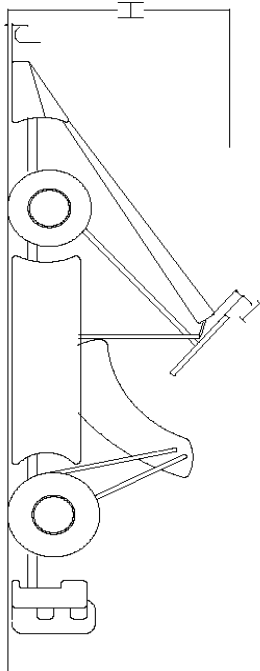

Kart Dimensions		
All Measurement Are Done with Wheels Straight Ahead and No Driver		
Letter	Description	Measurement
H	Maximum Height	26"
I	Maximum Height of Fairing Above Steering Wheel	1"
J	Minimum Between Ground to Nose and Ground to Front of Side Pod	1/2"
	Maximum Between Ground to Nose and Ground to Front of Side Pod	2 5/8"

Kart Dimensions		
All Measurement Are Done with Wheels Straight Ahead and No Driver		
K	Maximum Center of Rear Axle to Back of Bumper	15 1/2"
L	Maximum Center of Front Axle to Front of Nose	26 9/16"
M	Minimum Between Rear Tire and Bumper	1"

201.26.1 Minimum & Maximum Rear

Wheel/Tire Width:

Micro & Mini Swift – Minimum 41"
Maximum 50"

Junior & Senior Classes – Minimum 53"
Maximum 55 1/8"

*** This is for all race conditions.**



2023 USPKS Rule Book

202 Tires & Fuel:

202.1 Tires (Slicks):

MG spec tires shall be used; MG "SH" Reds 4.60 & 7.10 shall be CIKF/Z Option; MG "SM" Yellows 4.60 & 7.10 shall be CIKF/Z Prime; see class specifications for type and size. Tire treatments of any kind and/or tire warmers are illegal. All classes are required to qualify on sticker tires for the event. Swift classes shall run the same qualifying tires for all other races of that event. All Junior and Senior classes must scan eight (8) tires, four (4) fronts & four (4) rears that can be used for qualifying and all other races of the event.

* **All competitors must take all tires with them at the end of the event or they will be charged for any disposal fees.**

202.2 Rain Tires:

MG WT and SW spec tires shall be used; see class specifications for type and size. Tire treatments of any kind and/or tire warmers are illegal.

* **No limit on the number of rain tires.**

202.3 Tire Scanning:

Tire scanning shall be done before the time published on the Timeline or 15 minutes before the official fourth (4th) round of practice starts outside of late entries or arrivals. Anyone that fails to scan tires before the deadline on the official practice day will lose their fastest lap in qualifying.

202.3.1 Rain Tire Scanning:

Rain tires do not need to be scanned.

202.4 Spec Fuel:

All classes shall run the USPKS designated spec **VP Racing Fuel** MS98 that is supplied at each track. Refusal or failure to pass the fuel test will lead to disqualification or suspension. Some fuel testing procedures being used are Digation, hydrometer and visual. Tech officials will use these and any other necessary means to declare all fuels legal.

202.5 Spec 2 Cycle Oil:

ELF - HTX 909 is the spec oil for all 2 cycle classes.

Mixing ratio will be 1 liter of Elf HTX 909 to 5 gallon of MS98 VP Fuel.

It is very important that you rinse out your oil bottle at least two (2) times and mix your fuel/oil mixture up very good as the oil will settle to the bottom.



2023 USPKS Rule Book

300 Race Information:

301 Flags:

301.1 Green Flag:

A green flag lets competitors know the track is clear for practice or competition; it is also used to start or restart a race.

301.2 Yellow Flag:

A yellow flag alerts competitor of an unsafe condition in that part of the track. A waving yellow flag means there is trouble on the track. Drivers are to hold their position in these areas and shall not pass another competitor until they have passed the waving caution area. A standing yellow is an "advisory" and means there is possible danger near the racing surface. Passing is allowed when a standing yellow is displayed. When a double yellow flag is displayed by the starter it signifies a full course caution. Drivers shall proceed at a moderate pace with no passing allowed.

301.3 Red Flag:

A red flag alerts competitor of a halt to racing and to stop as soon as they can do so safely. Drivers may be directed to proceed to the front stretch or other designated area if it can be done safely. Corner workers will wave yellow and black flags to indicate a red flag situation. Any driver disobeying a red flag shall be disqualified. Participants, crew or family members are not allowed on the racing surface during a red flag.

301.4 Crossed Flags:

A crossed white and green flag indicates the race has reached the halfway point.

301.5 Two Rolled Flags:

Two rolled flags (green and white) are used to let the competitors know there are two laps remaining in that race.

301.6 White Flag:

A white flag lets competitors know they are starting the last lap of the race. If the white flag has been waved the checkered flag will follow even if it is waved with another flag, i.e., red, yellow or black.

301.7 Checkered Flag:

The checkered flag indicates the race or practice session has concluded, and all competitors shall slow down to a moderate pace, and safely proceed to the scale or pit area as required to do so.

301.8 Waving Checkered with Red:

A waving checkered with a waving red is used to alert the competitors of trouble on the racing surface. Racing back to the start/finish line is not allowed. Competitors shall proceed to the finish line if it can be done safely and follow the direction of corner workers. Scoring will revert to the last completed lap.

301.9 Black Flag:

A waving black flag is used to inform a competitor they need to exit the race course and proceed to the scale or pit area due to a rule infraction; the flagman will make every attempt to display the kart number of the driver receiving the black flag. If a competitor ignores a black flag it could lead to additional penalties. A rolled black flag is a warning usually given for unsafe or unsportsmanlike driving. If the actions continue it could lead to a waving black flag and disqualification.



2023 USPKS Rule Book

301.10 Black Flag with Orange Circle:

A waving black flag with orange circle is used to inform a competitor of a mechanical or tech issue. The driver should exit the race course and proceed to the scale. The flagman will make every attempt to display the kart number of the driver receiving the black flag with orange circle. If the competitor exits the race course/track prior to receiving the checkered flag, the competitor will be scored with a DNF (Did Not Finish) and be awarded points based on their position at the end of the race. If the competitor does not exit the track in a timely manner or ignores the black flag with orange circle, scoring will stop and the competitor will be DQ'ed.

301.11 Blue/Blue with Yellow Diagonal Stripe Flag:

A blue/blue with yellow diagonal stripe flag is used to alert competitor that they are about to be lapped and shall allow the lead karts the preferred racing line to complete the pass.

302 From Grid to Tech:

302.1 Communication:

Driver cannot receive or send any type of radio communication.

302.3 Track Layout:

All competitors shall observe the track layout and rotation by not cutting across curbs or driving around pylons. Cutting the track or ignoring track layout can result in penalties or disqualification; this includes the cool down lap after the checkered flag has been waved.

302.4 Number of Karts Allowed on Track:

USPKS has the right to control the number of karts allowed on the track depending on size of track, speed and level. If it is determined that the number of karts entered in a class is unsafe for the track, the Officials will decide on what actions will be taken to make the racing safe; this could reduce the number of laps for that class. This will be communicated to all in the affected class before any actions are taken.

302.4.1 Number of Karts Required for Class:

If after two consecutive events the kart count is not ten (10) or more karts, the class may be dropped.

302.5 Quiet Grid:

Engines shall only be run in the competitor's assigned pit area or adjacent to your assigned pit area (aisle). Running the engine on your way to the grid or on the grid is not permitted.

2023 USPKS Rule Book

302.6 Push Back Nose Inspection:

All non-kid kart classes must utilize a front nose equipped with a CIK-homologated pushback nose system, with a maximum of two CIK-homologated clamps. OEM clamps may be substituted for, but must be CIK-homologated for that purpose. Competitors will present their karts to the grid with the nose cone in place and the clamps on, zip ties may be used to hold the clamps to the bumper but shall not hold the clamp from opening. The grid official will do an inspection of the nose while on the kart. The official will be checking for holes and to verify that the nose has not been damaged to the point that it has lost its rigidity. During inspection the competitor may be asked to remove one or both clamps by hand and then re-install them. The nose is a tech item, and therefore may be inspected at any time during the day by series officials. If any officials ask to inspect the nose, the driver or their mechanic must remove it for inspection, without the use of any tools. If the nose, clamps, or blocks, are found to be illegal, or the mechanic/driver is unable to remove it for inspection when asked, there will be a 4-position penalty assessed. Additional penalties up to disqualification may be assessed depending on the infraction.

302.7 Bumper to Nose Cone Clearance:

The nose cone shall be a minimum of 27mm (roughly the size of a 13/16 spark plug socket) from the bumper to the nose cone in all places (Red Area on both sides). Inspection may be done before entering the track. If the correct clearance is not maintained, the competitor will be required to correct or change parts prior to entering the track.

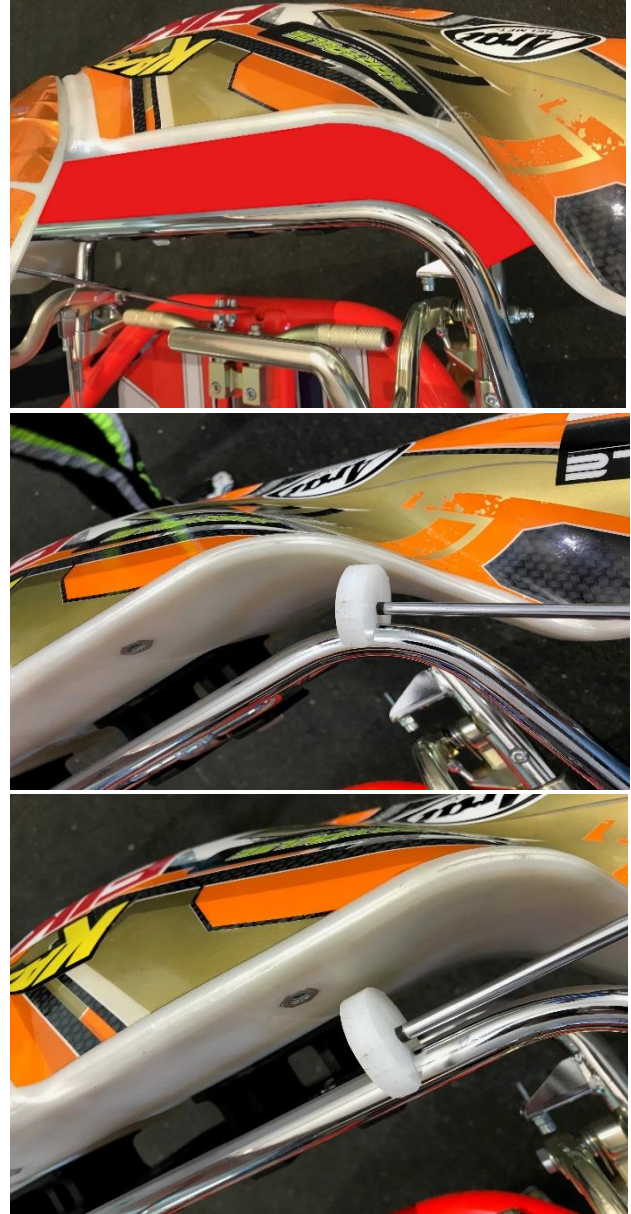



2023 USPKS Rule Book

302.8 Pre-Grid:

Nose cone inspection and any last-minute changes will be done before entering the grid area.

302.9 Controlled Grid:

No kart stands, baby strollers or pets are allowed on the grid. USPKS will allow the driver and one (1) other person to enter the grid area the same time the kart enters the grid. No one else will be allowed in the grid area.

302.10 Grid:

All competitors are responsible to be on the grid on time for their class during practice and races. Their transponder shall be charged and properly mounted on the kart.

302.10.1 Working on the Grid:

Working on your kart while on grid is prohibited unless it has been approved by an USPKS Official

302.11 Entering the Track for Qualifying:

Once the field is released from the grid to begin qualifying, a competitor has 30 seconds to enter the track. If engine fails to start, they have 90 seconds from the time the grid is released to get their kart on track.

302.12 Race Day 90 Second Rule:

Heats and Finals, driver will have 90 seconds after their class is released from the grid to get their kart started and join the rest of the class on track. The driver and kart must be in their starting position and the driver seated in their kart when the class is released to go on the track for the 90 second rule to go in effect. After the 90 seconds has expired the grid is closed and no karts may enter the racing surface. This rule cannot be used to change tires from dry to wet or wet to dry.

302.13 Driver Unable to Start:

If a driver has scratched his entry by notifying Chief Scorer or Race Director, the grid lineup will be adjusted by crossing over from the point of the scratch to the last starting position. If a driver is unable to start the race after the class leaves the grid, the line in which the driver falls out of will move forward; there will be no crossover of positions.



2023 USPKS Rule Book

302.14 Penalties:

Drivers may be subject to any of the infractions and their consequent repercussions listed below. Possible penalties are not limited to those listed below, and repercussions may be altered to reflect extenuating circumstances, both of these decisions are at the discretion of the officiating team.

Penalty	Possible Repercussions	Description
Avoidable Contact	3 or 5 positions; placement behind the offended competitor	Using the front bumper to move a competitor off-line and complete a pass; not leaving sufficient space for a driver who is or is almost fully alongside on the exit of a corner
Blocking	3 or 5 positions	Making more than one move away from the line chosen at corner exit to defend from a kart behind
Swerving	5 or 15 positions; Unsportsmanlike DQ	Moving towards a competitor down the straight who already has their front bumper up to the rear wheel of the leading kart, if contact is made this will be 15 positions
Retaliation	15 positions	Taking retributory and aggressive action against a driver who has wronged them
Track Cutting	5 positions minimum	Going 4 wheels off to shorten the track (The inside edge of the curb is defined as the edge of the track)
Tram Line Violation	3 seconds	Exiting the tram lines prior to the green flag being displayed
Jump Start (Singlespeed)	Severity Based	Off-pole accelerating prior to the pole sitter to the degree they gain a significant advantage
Jump Start (Shifter)	3 seconds	Accelerating prior to the official race start as described in the driver's meeting
Unsportsmanlike Conduct	DQ	Making obscene gestures, instigating an altercation in the scale line, and other actions which could be determined to be unsportsmanlike in nature
Passing After Checkered	Severity Based	Overtaking a kart following the checkered flag that is still driving at a reasonably fast pace
Forcing air into the air box	5 positions per instance	Placing a hand behind the inlet tubes in an attempt to force air into them

2023 USPKS Rule Book

302.14.61 Push Back Nose Cone Penalties:

Push back nose cone mounts have been instituted for the purpose of reducing the contact between karts, intentional, or otherwise. Of particular importance to a safe start, is the need to leave adequate space between karts on the formation and pace laps. Two to three feet of “cushion” space should be left between you and the kart in front of you during the pace and formation laps to ensure that there is no contact. Failing to leave adequate space between your kart and the kart in front of you is not an excuse for a dislodged nose cone.

Push back mounts shall remain in the correct position during any time of competition. Drivers should take care to allow enough distance between themselves and the kart in front of them during warm up, pace laps, start of the race, and scale line, to prevent contact that may dislodge the nose cone. If any part of the top or bottom bar/bumper is in the drop-down area as pictured below, the competitor will be assessed a **3 second** penalty per side with a maximum penalty of **6 seconds**.

Intentionally dislodging another competitor's nose cone will be considered unsportsmanlike conduct and subject to appropriate penalty. The Black Flag with Orange Circle will **NOT** be given to any competitor whose nose cone is no longer in the correct position. **Any competitor that attempts to put the nose cone back to its correct position while on track or before crossing the scale will be disqualified for the event.** If a dislodged nose cone penalty is issued, you may protest it using the normal protest channels, but only conclusive **on-board** video evidence will be considered.

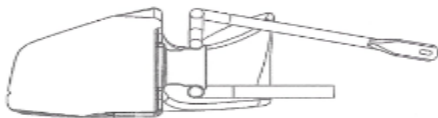

Correct Position Pictured Above

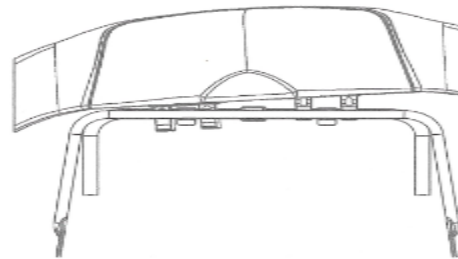
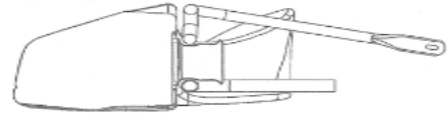

Incorrect Position Pictures Above

302.15 Practice:

Drivers will practice with their class. If a driver practices with another class without USPKS approval they will be penalized. Testing Monday thru Wednesday the week of the event will not be permitted at the track at which the event will be held unless otherwise published by USPKS. Anyone violating this rule will not be allowed to practice on the official practice day. Furthermore, they must participate in qualifying and start at the back of all heat races. Starting position for the finals will be based on the accumulated points they received from the heat races. Anything outside of a concession rental kart is not allowed.



2023 USPKS Rule Book

302.16 Lapped Competitor:

In all classes a competitor that is about to be lapped will be black flagged. The competitor will be placed in the on-track position at the time of the black flag and receive points for that position.

302.17 Slowing or Stopping on Race Track:

If your kart slows from racing speed during practice or a race due to mechanical issues, or to exit the race course, the driver shall raise a hand above their head and wave to alert other drivers behind them. If a kart comes to a stop on the race track during practice or during a race, the driver shall raise a hand above their head and wave to alert other drivers. When safe to do so the driver must exit their kart and remove it from the racing surface.

302.18 Exiting Your Kart on Track:

KA100, X30 and KZ competitors are allowed to exit their kart to untangle, or free their kart from an object, providing the engine is off before exiting the kart. Once the kart is free, the competitor must be safely seated in kart before restarting and safely rejoining the race. If you become lapped while stopped, you may not rejoin the race. (See Re-entering the Racing Surface) Swift classes are not allowed to exit their kart and continue the race. All competitors are expected to exit their kart to help clear the track.

302.19 Re-entering the Racing Surface:

Other than leaving the grid area, if a driver leaves the racing surface during practice or a race, they should re-enter the racing surface at a point not in the racing groove, for example on a straightaway or other spot that can be done safely and not obstruct another driver. When re-entering, the driver shall yield to drivers on the racing surface. The driver shall not advance any positions or gain

any advantage during this time. Race officials will be critical of re-entry safety.

302.20 Restarting Engine:

After leaving the grid area and before the green flag, an engine may be restarted with the onboard starter and rejoin in their starting position if this can be done before reaching the commitment zone, the Flagman can choose to start the race at their discretion regardless of whether or not the late arriving driver has regained their position. If the engine is restarted after the green flag the competitor will re-enter the racing surface at a point not in the racing groove, for example on a straightaway or other spot that can be done safely and not obstruct another driver. The driver shall not advance any positions or gain any advantage during this time. Any kart that does not have an onboard starter will not be allowed to restart after leaving the grid unless it is after a red flag

302.21 No Passing Area (waving yellow flag):

If a waving yellow flag is displayed, passing is not allowed in that area.



2023 USPKS Rule Book

302.22 Karts/Drivers Involved in Red Flag:

Driver's safety equipment and kart may be inspected by USPKS if they are involved directly or indirectly in a red flag incident. The Race Director has the right to prohibit a driver from restarting a race if he feels it is not safe for them to do so. **Working on karts involved in a red flag is not allowed unless a complete restart has been determined by USPKS officials and permission has been given (this is for karts involved in the red flag incident only).** If any work or repairs are performed during a red flag stoppage, it must be approved by a USPKS official and the driver will start at the back of the field. If a driver is unable to "leave" with the rest of the field during the restart procedure, there is no 90 second rule; he/she will not be allowed to continue. If a driver cannot weigh in with their kart due to medical personnel examining the driver, the Race and/or Tech Director can waive the weigh-in requirement at the scales and the driver will receive points for their finishing position.

302.23 Restarts:

The starting order after a red flag will be determined by the running order of the last completed lap. The kart or karts causing or directly involved in the red flag will be placed at the back of the starting order. A completed lap is after all karts on the lead lap have crossed the finish line or scoring loop.

302.24 Loose or Missing Components:

All components shall be fastened and in place at the start of a race prior to the green flag; if not, a competitor could be black flagged. All karts must finish the race with all components subject to tech still intact in the manner the rule specifies. Any competitor that loses a 'spec' or 'tech-able' component may be black flagged. Examples include a nose, side pod, bumper or exhaust. A loose but intact exhaust may be black flagged. When leaving the grid, rear bumpers must be securely attached to the kart as designed by the manufacturer. Aftermarket bumper safety

kits, or other means that keep the bumper secured in its original location are acceptable, even if the bumper itself drags on the track in the event of a broken bumper bolt while on the track. Bumpers **WILL NOT** be allowed to drag more than a few inches beyond the normal mounting location. If bumper becomes completely detached from one side of the kart, or is deemed unsafe by track officials, it will be grounds for a mechanical black flag and/or disqualification. The spirit and intent of this rule is to allow racers to continue on with a broken bumper bolt, as long as it remains safe.

302.24.1 Losing Fluid on Track:

Any kart losing fluid on track will lose their fastest lap if it happens during qualifying or, will be black flagged if during practice or a race.

302.25 Slick or Rain Tire Condition:

If a race is started in dry conditions, and rain begins causing it to become too wet or unsafe, the race can be stopped to allow competitors to change to rain tires. Pit stops are not allowed. A minimal amount of time will be allowed for that change to occur. When USPKS determines wet conditions, all competitors will use the spec rain tire for their class. The first class that this affects will have a minimum of fifteen (15) minutes to change from dry to wet setup or from wet to dry setup if USPKS determines wet or dry condition. If USPKS determines competitor's choice, the competitor is responsible for determining if they would like to compete on spec rain tires or spec slick tires. If a race is started in dry conditions, but wet weather is imminent and competitor's choice has been declared resulting in the field being a mix of slicks and rain tires, the race will not be stopped so as to not take away the strategic decision/advantage by these competitors. An exception may occur if it is determined by USPKS officials that conditions have become too unsafe for even those on rain tires. All four tires must slicks or rains, mixing tires is not allowed.



2023 USPKS Rule Book

302.25.1 Reducing Race Length (in wet):

If USPKS officials declare wet conditions, all competition sessions (races) may have laps reduced by 20% for each session. The Series will make every effort to resume published lap counts if conditions allow the return to "Competitors Choice." Series officials reserve the right to adjust lap counts for extenuating circumstances.

302.26 Exiting the Race Track:

After the checkered flag has been displayed all drivers shall exit the track at the designated area. Driving recklessly or intentionally damaging another driver's kart after the checkered flag is Unsportsmanlike Conduct, and grounds for penalization up to and including ejection from the event. After each race all drivers are responsible for crossing the scales and reporting to post-race inspection if required. Any driver not crossing scales or missing post-race tech will be disqualified.

302.27 Completed Race:

Every effort will be made by USPKS to complete every lap of every race. If the checkered flag appears before (or after) the last scheduled lap, drivers are expected to race to the checkered flag, and the race will be deemed complete. Competitors will be scored as per normal procedures, as they crossed the line. In the event of an unexpected situation, such as an accident requiring assistance, poor weather, time limits or other extenuating circumstances, a red flag may be displayed. At that point, race officials may deem the race complete if necessary. If the race is deemed "complete" by race officials, scoring will go to the last completed lap, with any drivers causing/contributing (Race Director's discretion) to the red flag being placed in the rear of the field. A lap is considered to be complete when all competitors on the lead lap have crossed the finish line (scoring loop).

302.28 Incomplete Race:

If the event cannot be completed due to weather or other circumstances, points and awards will be given based on the total points accumulated from qualifying results and heat races that have been completed. For any class that did not complete qualifying, entrants shall be awarded 200 points.

302.29 Combining Classes:

USPKS has the right to combine classes. Lap times and experience will be taken into account in making this determination.

302.30 Event Format:

Every effort will be made to follow the timeline that will be published and distributed at registration.

302.31 Qualifying:

Qualifying will be by class for a set amount of time or laps. The Race Director will determine the time or laps allowed and the number of karts allowed on track for a qualifying session. If the class is split into two groups for qualifying it is the driver's responsibility to know what group he/she is in and what time to be on the grid. Groups will be posted on the lineup/results board.

302.31.1 Qualifying Tie Breaker:

If there is a tie during qualifying it will be broken by reverting back to the second fastest lap by each competitor and then to the third fastest lap if needed. If there is still a tie we will revert to the last round of practice.

302.32 Heat Races:

The grid lineup for the heat races will be determined from qualifying sessions.



2023 USPKS Rule Book

302.33 Finals:

Grid lineups for the Final races will be based on points acquired from heat race finishing positions, accumulation from all heat races. A tie breaker is determined from qualifying order.

302.34 Clearing the Scale:

All drivers must cross the scale after each official scored qualifying session and race. They must meet the minimum weight per class. Any competitor not meeting the minimum weight or failing to cross the scales will be DQ'ed unless the Race or Tech Director has waived this requirement due to injury or illness. No one but the driver is allowed to touch the kart until it has cleared the scale, unless otherwise approved by USPKS.

302.34.1 Driving on the Scale:

All karts shall come to a complete stop before entering onto the scale. Any driver that drives their kart on the scale, engine running or not, and has to use their brakes to stop on the scale could be penalized or DQ'ed.

302.34.2 Drinking Fluids Before Clearing the Scales:

Drinking water prior to clearing the scales is prohibited unless authorized by the Race and/or Tech Director beforehand. If approved a driver may drink water or sports drink from a clear plastic bottle (maximum 500ml) is allowed in scale area before weighing. However, any driver pouring water over head or driving equipment may be penalized.

302.35 Data Acquisition:

Data acquisition systems can be used to retrieve any of the following: RPM, lap times, head temperature, exhaust temperature, water temperature, speed, pedal location, brake/master cylinder pressure, GPS tracking or computer scoring. Any telemetry, other sensors or inputs shall be removed or disconnected while kart is on track during official practice or race days. Data downloading can only be done in the pit area. Only one beacon for each type of system is allowed on the track and will be placed at the USPKS approved location. GPS systems are legal.

302.36 Reporting to Tech:

The top five (5) of each official scored qualifying session and race shall report to the tech area and not leave until released by one of the tech officials. The tech officials have the right to check as few or as many karts as they deem necessary.

302.36.1 Tech Area:

Only the driver and one (1) tuner/mechanic are allowed in the tech area unless cleared by one of the tech officials.

302.36.2 Failure to Report to Tech:

Failure to report to tech could lead to disqualification and/or suspension.

302.36.3 Refusal of Tech:

Refusal of tech could lead to disqualification and/or suspension.



2023 USPKS Rule Book

302.37 Impound Parts or Equipment:

USPKS has the right to impound any parts or equipment for further inspection. If no issues were identified after further inspection, the parts or equipment will be returned to the competitor. If parts or equipment are found illegal USPKS has the right to keep the parts or equipment and penalties up to and including suspension could be handed out from the result of the inspection. This includes any items found during pre-race, tech or any inspection of parts or equipment.

302.38 Race Starts:

Karts shall approach the flagman within the tram lanes at a slow and consistent pace. The pole sitter will accelerate when the flagman throws the green, at this time all drivers may exit the tram lanes. The off-pole driver will not accelerate prior to the pole sitter or they subject themselves to a jump start penalty, the severity of which is based on the severity of the offense. Drivers starting down the order are expected to maintain less than a three (3)-foot gap to the kart ahead at all times once they enter the tram lanes. Exiting the tram lines prior to the green flag will subject a driver to a three (3) second time penalty.

302.38.1 Shifter Starting Procedure:

Lights will be used when available, otherwise a flagman will be used to start the race. All karts will start from a standstill, movement prior to the official race start will result in a three (3) second time penalty. Every grid box will be utilized, unless the race director indicates otherwise for safety reasons. In the event a driver stalls prior to the start, they are expected to wave their arms above their head, at which point the field will be waved around. The driver who stalled will start from the rear, and their grid box will be left empty.

302.37.2 Shifter Lane Selection:

At the start of the first heat, the polesitter can elect to use either lane. They will be forced to continue with this lane selection through the rest of the heat races or face a three (3) second penalty in each heat. This selection does not impact the rest of the grid, and they will start in their assigned rows. The same rule applies for the final, if the pole sitter from qualifying remains on pole, they may select a different lane from the heats at this time if they elect to.



2023 USPKS Rule Book

303 Race Format, Scoring & Points:

303.1 Race Format:

1st official day of the event (Friday) – Five (5) rounds of practice with the final session being qualifying, qualifying line up from the previous round of practice times.

2nd official day of the event (Saturday) – Warmups & three (3) heat races, heat race line ups from qualifying.

3rd official day of the event (Sunday) – Warmups, LCQ's & finals, finals line ups from heat race points.

303.2 Scoring:

Scoring results are official. Data acquisition will not supersede official results.

303.2.1 Scoring Protests:

Error in points must be contested within two (2) weeks of posting by contacting Chief Scorer.

303.2.2 Scoring Abbreviations:

DNS – (Did not start) A competitor who is a DNS shall be awarded last place points. If more than one competitor is a DNS, then the finishing tiebreaker shall be according to their respective qualifying or starting position.

DNF – (Did not finish) A competitor who takes the green flag but becomes a DNF shall be awarded points based on their position at the end of the race. A competitor who is a DNF but does not take the green flag shall be considered a DNS and awarded points in accordance with the DNS point rule.

DQ – No points

303.2.3 Penalized Starting Positions:

Penalized in Qualifying – Receives championship points for penalized position if applicable. Starts all heats from penalized position.

DQ after Qualifying – Loss of championship points for qualifying if applicable. Starts all heats at the back.

Penalized in Heat – Receives championship points for penalized position in that heat. Starts next race from qualifying position or total points from heats.

DQ in Heat – Loss of championship points for that heat. Starts next race from qualifying position or total points from heats.

Penalized in final – Receives championship points for penalized position.

DQ in final – Receives zero (0) championship points for final.



2023 USPKS Rule Book

303.2.4 Unforeseen Circumstance:

Once a race event has begun; if an official session cannot be run due to unforeseen circumstances, such as inclement weather or time constraints, all competitors will receive points based on the guidelines below. If only Qualifying was completed, with the remainder of the day canceled, competitors will receive appropriate points for Qualifying, and 200 points for the Final event. If more than 1 session is completed, then Final points will be assigned based on the result of that event.

Example 1: Qualifying and Heats are completed. Final points are assigned to heat race total points.

Example 2: Qualifying is canceled, but Heats and Final are completed. There are no points for Qualifying, but points are awarded for Heats and Final.

*** Under no circumstances will points be awarded twice for the same competition session. In the interest of fairness to all parties, Series Officials reserve the right to modify this rule at the track, if necessary.**

303.3 Championship Points:

All classes run for a single points championship. Championship points are based on qualifying, finishing order in heat races and the final.

303.3.1 USPKS Points:

1. USPKS will count four (4) of the five (5) races, one (1) drop is allowed for the season. Disqualification can be used as a drop unless the DQ is for unsportsmanlike conduct, or the use of remanufactured or counterfeit parts. If a competitor is deemed in violation of the spirit and intent rule, he or she may be disqualified netting zero points

2. for the day in the class of the DQ without the option of dropping that race from the season points total if applicable.
3. Competitor must attend any 4 of 5 scheduled race events in order to qualify for Championship Awards.
4. Top place finishers must attend the Banquet to accept their earned trophy and awards.

303.3.2 Points Breakdown:

303.3.2.1 Qualifying Points:

1 st – 50	2 nd – 40	3 rd – 30
4 th – 20	5 th – 10	

303.3.2.2 Heat Race Points:

1st	100	18th	39
2nd	95	19th	37
3rd	90	20th	35
4th	85	21st	33
5th	80	22nd	31
6th	76	23rd	29
7th	72	24th	27
8th	68	25th	25
9th	64	26th	23
10th	60	27th	21
11th	57	28th	19
12th	54	29th	17
13th	51	30th	15
14th	48	31st	14
15th	45	32nd	13
16th	43	33rd	12
17th	41	34th	11
		35th or higher	10



2023 USPKS Rule Book

303.3.2.3 Final Race Points:

** Below is based on 48 entries, plus entries column will change based on number of entries in the class*

Finish Position	Points	Plus, Entries	Total
1st	300	48	348
2nd	285	48	333
3rd	270	48	318
4th	255	48	303
5th	240	48	288
6th	228	48	276
7th	216	48	264
8th	204	48	252
9th	192	48	240
10th	180	48	228
11th	171	48	219
12th	162	48	210
13th	153	48	201
14th	144	48	192
15th	135	48	183
16th	129	48	177
17th	123	48	171
18th	117	48	165
19th	111	48	159
20th	105	48	153
21st	99	48	147
22nd	93	48	141
23rd	87	48	135
24th	81	48	129
25th	75	48	123
26th	69	48	117
27th	63	48	111
28th	57	48	105
29th	51	48	99
30th	45	48	93
31st	42	48	90
32nd	39	48	87
33rd	36	48	84
34th	33	48	81
35th	30	48	78
36th	28	48	76
37th	26	48	74
38th	24	48	72
39th	22	48	70
40th	20	48	68
41st	19	48	67
42nd	18	48	66
43rd	17	48	65
44th	16	48	64
45th or higher	15	48	63

** Maximum points for a perfect weekend with 48 entries would be 698 points or, 650 plus entries*



2023 USPKS Rule Book

303.4 Tie Breaker:

If there is a tie at the finish of a race the tie will be broken by reverting back to qualifying. The person that qualified the highest will receive the higher finishing position of the tie. If a tie is still present, then they will use the finishing position of the previous race of that event. If there is a tie in the final points championship between two (2) or more drivers, each driver will receive one (1) point for each of the items listed below step by step until the tie is broken. If one (1) driver gets two (2) points and the other driver gets one (1) point in the first step, then the driver that received two (2) points would be the champion. If it is still tied the process will continue until the tie is broken.

- Step 1) Number of Final Wins
- Step 2) Number of Heat Race Wins
- Step 3) Number of Fast Time Awards
- Step 4) Number of Final 2nd Place Finishes
- Step 5) Number of Heat Race 2nd Place Finishes
- Step 6) Number of Final 3rd Place Finishes
- Step 7) Number of Heat Race 3rd Place Finishes, and so on until the tie is broken.

303.5 Year End Awards:

All year end awards/certificates shall be used with sponsors of the USPKS.



2023 USPKS Rule Book

400 Series Class

Structure:

401 USPKS Class

Structure:

Push Back Nose is required in all classes during any official practice or race.

401.1 IAME Micro Swift:

Age: 7 – 10 years old

Minimum Weight: 225 lbs.

Engine: IAME Swift 60cc TAG Engine

Carburetor: Tillotson HW-31A

Exhaust: IAME OEM Swift 16mm (No-Go) Restricted Header & Pipe

Tires: Slicks MG "SH" Red CIKF/Z Option

4.60 Fronts & Rears

Rains MG "WT" or "SW" 4.20 Fronts & Rears

* Qualify on four (4) new/sticker tires, use same tires for any race condition for the remainder of the event.

*** SFI 20.1 or other USPKS approved Chest Protectors are MANDATORY for all drivers under 13 years old (Section 102.3).**

* Must run Cadet Bodywork including the Cadet nose on Cadet chassis.

*** See Section 504 and USPKS Website for additional Engine Rules.**

401.2 IAME Mini Swift:

Age: 8 – 12 years old

Minimum Weight: 245 lbs.

Engine: IAME Swift 60cc TAG Engine

Carburetor: Tillotson HW-31A

Exhaust: IAME OEM Swift Header & Pipe

Tires: Slicks MG "SH" Red CIKF/Z Option

4.60 Fronts & Rears

Rains MG "WT" or "SW" 4.20 Fronts & Rears

* Qualify on new/sticker tires, use same tires for any race condition for the remainder of the event.

*** SFI 20.1 or other USPKS approved Chest Protectors are MANDATORY for all drivers under 13 years old (Section 102.3).**

* Must run Cadet Bodywork including the Cadet nose on Cadet chassis.

*** See Section 504 and USPKS Website for additional Engine Rules.**

401.3 IAME KA100 Junior:

Age: 12 – 15 years old

Minimum Weight: 320 lbs.

Engine: IAME KA100

Carburetor: HW-33A

Exhaust: IAME OEM KA100 22mm (No-Go) Restricted Header & Pipe

Tires: Slicks MG "SH" Red CIKF/Z Option

4.60 Fronts & 7.10 Rears

Rains MG "WT" or "SW" 4.20 Fronts & 6.00 Rears

* Total of eight (8) tires, four (4) fronts and four (4) rears can be used for any qualifying or race condition for the remainder of the event. Must qualify on new/sticker tires.

*** SFI 20.1 or other USPKS approved Chest Protectors are MANDATORY for all drivers under 13 years old (Section 102.3).**

*** See Section 505 and USPKS Website for additional Engine Rules.**



2023 USPKS Rule Book

401.4 IAME X30 Junior Pro:

Age: 12 – 15 years old

Minimum Weight: 320 lbs.

Engine: IAME X30

Carburetor: Tillotson HW-27A

Exhaust: IAME OEM X30 22.7mm (No-Go) Restricted Header & Pipe

Tires: Slicks MG "SH" Red CIKF/Z Option

4.60 Fronts & 7.10 Rears

Rains MG "WT" or "SW" 4.20 Fronts & 6.00 Rears

* Total of eight (8) tires, four (4) fronts and four (4) rears can be used for any qualifying or race condition for the remainder of the event. Must qualify on new/sticker tires.

*** SFI 20.1 or other USPKS approved Chest Protectors are MANDATORY for all drivers under 13 years old (Section 102.3).**

*** See Section 506 and USPKS Website for additional Engine Rules.**

401.5 IAME KA100 Senior:

Age: 15+ years old

Minimum Weight: 360 lbs.

Engine: IAME KA100

Carburetor: HW-33A

Exhaust: IAME OEM KA100 Header & Pipe

Tires: Slicks MG "SH" Red CIKF/Z Option

4.60 Fronts & 7.10 Rears

Rains MG "WT" or "SW" 4.20 Fronts & 6.00 Rears

* Total of eight (8) tires, four (4) fronts and four (4) rears can be used for any qualifying or race condition for the remainder of the event. Must qualify on new/sticker tires.

*** See Section 505 and USPKS Website for additional Engine Rules.**

401.6 IAME X30 Pro:

Age: 15+ years old

Minimum Weight: 365 lbs.

Engine: IAME X30

Carburetor: Tillotson HW-27A

Exhaust: IAME OEM X30 Header & Pipe

Tires: MG Slicks MG "SM" Yellow CIKF/Z Prime

4.60 Fronts/ 7.10 Rears

Rains MG "WT" or "SW" 4.20 Fronts & 6.00 Rears

* Total of eight (8) tires, four (4) fronts and four (4) rears can be used for any qualifying or race condition for the remainder of the event. Must qualify on new/sticker tires.

*** See Section 506 and USPKS Website for additional Engine Rules.**

401.7 IAME KA100 Masters:

Age: 30+ years old or 15+ if driver over 200lbs.

Minimum Weight: ~~380 lbs.~~ 390 lbs.

Engine: IAME KA100

Carburetor: HW-33A

Exhaust: IAME OEM KA100 Header & Pipe

Tires: Slicks MG "SH" Red CIKF/Z Option

4.60 Fronts & 7.10 Rears

Rains MG "WT" or "SW" 4.20 Fronts & 6.00 Rears

* Total of eight (8) tires, four (4) fronts and four (4) rears can be used for any qualifying or race condition for the remainder of the event. Must qualify on new/sticker tires.

*** See Section 506 and USPKS Website for additional Engine Rules.**



2023 USPKS Rule Book

401.8 Pro Shifter:

Age: 15+ years old

Minimum Weight: 390 lbs.

Engine: ~~IAME SSE~~ or KZ

Carburetor: Tillotson HB-15A or Dellorto VSH30

Exhaust: CIK-FIA Approved

Tires: MG Slicks MG "SM" Yellow CIK/F/Z Prime

4.60 Fronts/ 7.10 Rears

Rains MG "WT" or "SW" 4.20 Fronts & 6.00 Rears

* Total of eight (8) tires, four (4) fronts and four (4) rears can be used for any qualifying or race condition for the remainder of the event. Must qualify on new/sticker tires.

* **Competitor running the KZ engine must have in their possession a printed copy of the CIK paperwork to present to tech.**

* **See Section 507 and USPKS Website for additional Engine Rules.**

500 Engine Rules:

501 General Engine Rules:

501.1 Comparison of Known Stock Part:

Any part may be compared to a known stock part for determination of legality.

501.2 Engine Pressure/Vacuum Testing:

USPKS may perform a pressure or vacuum test to ensure extra air is not being pulled into the engine for any performance gain. Both pressure and vacuum tests may be performed — engine must hold 5 psi for 60 seconds and/or 5" HG of vacuum for 60 seconds.

501.3 Carburetor Return Spring:

All engines will be required to utilize an auxiliary carburetor spring; below are some examples. If a different type of spring other than one of the examples below is used, it must be approved by one of the Tech Officials.

***If no spring is used you will not be allowed on track.**



501.4 Clutches:

Clutches are required in all classes unless stated under class section.



2023 USPKS Rule Book

501.5 Engine Sealing:

It will be each driver's or guardian's responsibility to correctly seal the engine. If the competitor removes the seal under the direction of USPKS, they will receive another seal at no charge. If there is any question as to how to correctly seal the engine, see one of the Tech officials or see pictures in each of the engine sections.

501.5.1 KZ Engine Sealing:

The KZ class only may seal two (2) engines during the allotted time listed on the Timeline for the event. These engines may be used for any race condition during that event. Both sealed engines may be teched at any time.

501.5.2 Engine Seal Penalty:

If engine is not sealed after qualifying there will be no penalty if sealed under direction of USPKS official before leaving Tech area. If engine seal is missing after a Heat or Final the competitor will be DQ'ed for that race.

501.5.3 Tampering with Engine Seal:

Any competitor that tampers with any engine seal will be disqualified from the total event receiving zero points.

501.6 Engine Change:

A maximum of two (2) engines may be used. The primary engine must be recorded and sealed before qualifying. The second engine may be submitted later but must be recorded and sealed by Tech Director prior to any on-track use. Once the "back-up" engine is used it may no longer be used by another driver that day.

- 1) **Damaged engine change:** No penalty, competitor keeps earned spot.
- 2) **Undamaged engine change** – Competitor starts in the rear for upcoming race.

- 3) **Engine Change Tech** – The engine that is being changed or replaced will be teched and will be required to pass tech. If engine fails tech competitor will be DQ'ed for the last race.

501.7 Engine Components:

Engine components may not be changed for that day after qualifying, (i.e., carburetor or sealed exhaust) unless approved by a USPKS Tech Official. If any components are changed the competitor will be required to do so under the direction of a Tech Official. Rebuilding carburetor, replacing broken reeds or a cracked (not broken) exhaust is allowed with no penalty. Rebuilding carburetor, checking or replacing reeds can be done in your pit area as long as the engine seal is not cut, if seal needs to be cut it must be done under the direction of a Tech Official.

501.7.1 Loose or Missing Engine Components:

All engine components from the air box to the pipe must be properly attached from leaving the grid to the end of the race. If an engine component comes loose after crossing the start finish line and receiving the Checkered Flag, the competitor will keep their spot.

501.8 IAME Engine Claiming:

USPKS or IAME can claim IAME engines if they deem it necessary. The competitor will receive a new engine plus \$500 for a Swift or KA100, a new engine plus \$800 for an X30. Engine will include carburetor, air box, clutch, exhaust, electrical system and all parts that were supplied i.e. clutch cover. (Excludes cooling system)



2023 USPKS Rule Book

501.9 Cylinder Ports:

Must remain as manufactured. May be compared to a known stock part. No grinding, polishing, beveling, radiusing, chamfering, rounding or any deviation from the factory presentation will be allowed. Noncompliance with stock or not as manufactured includes any visible or measurable deviations. This may also include excessive wear that can be suspect of a performance enhancement.

501.10 Starter Batteries:

Must be of a sealed or dry cell design. All batteries used must be of enough capacity to start the engine.

501.10.1 Mounting Batteries:

All batteries are to be labeled with the kart number. They are to be affixed in one of the following manners: (1) Factory IAME box and strap with one 175-lb tie wrap, or (2) Aftermarket battery box with minimum of two 175-lb tie wraps.

At least one of the tie wraps shall be installed around the chassis.

501.10.2 Loss of Battery on Track:

If a competitor loses their battery while on track, they will receive the following penalty:

- 1) During practice, loses next round of practice
- 2) Last round of practice, loses fastest lap of qualifying
- 3) During qualifying, heat, LCQ or final, is DQ

501.11 Technical Tools:

The Tech Official may utilize any approved USPKS tool deemed necessary to assure all engines and equipment meet the requirements outlined in the USPKS rule book. This is not limited to but includes No Go Gauges, Cord

Width Gauges, Micrometers, Dial Caliper, Dial Indicator, Digatron Fuel Tester and Hydrometer.

501.12 No Go Gauges:

A No Go gauge is a non-adjustable tool that is used to verify a specified opening when inserted. No Go gauges shall be made from heat treated tool steel that is ground to finish size. The gauge or the gauge handle shall be clearly marked. Plug gauges are used to measure round openings. Gauges up to a diameter of 0.361" shall be round; gauges larger than 0.361" shall be ground on each side to achieve a blade width between 1/8" – 1/4" unless it is an engine manufactured gauge (See 509.3). Tolerance on gauges up to 0.750 is +0.0001" / -0.000" gauges larger than 0.750" +0.0003" / -0.0000". USPKS recommends that the gauges be held in aluminum handles.

501.12.1 Using No Go Gauges:

These gauges are used to check a specific round opening. If the gauge enters any part of a specific opening, the part is illegal and the competitor will be disqualified. When measuring chamfered or angled round opening, the gauge may enter the chamfer or angle area but the gauge shall not be self-supporting when part being checked is rotated to any angle. If gauge is self-supporting, competitor will be disqualified.

*** Dial Caliper cannot be used for measurements if stated No Go in the USPKS rule book.**

501.12.2 Cord Width No Go Gauges:

Cord width gauges shall be made from heat treated tool steel. They shall be 1/8" +/- 0.015" thick and the width tolerance is +0.0002 / - 0.0000". Gauges shall be marked with the width size. These gauges are used to measure port widths.

2023 USPKS Rule Book

501.13 IAME Supplied Tech Tools:

IAME Go, No Go gauges and cylinder inserts that have been furnished by IAME will be used as manufactured if available and meet the dimension listed in the PDF. If there is no gauge available by IAME or is not the correct dimension per the PDF a No Go gauge can be used as long as it meets 501.11 specs. or other tools listed in 501.10. These IAME Tech Tools can be found in the PDF's listed on the USPKS website. If these tech tools are not listed in the PDF's please contact the Tech Director for a list. These include but are not limited to, Go Gauge, Taper Gauge, No Go Gauge and Cylinder Inserts.

501.13.1 Head & Header Profile Gauges:

The IAME profile gauge must go into the head or header completely, see examples below. If the gauge will not seat as pictured below the competitor will be given the opportunity to clean the head or header with 2 (two) swipes of a rag. If the gauge will not seat completely after 2 (two) swipes with a rag it will lead to disqualification.



501.14 Piston Squish:

Squish is the smallest distance between the head and the piston. This is done with 0.0625" or 1/16" solder McMaster Carr part # 7667A32 (unless specified by manufacturer) that is inserted through the spark plug hole pointed at cylinder wall in line with the piston wrist pin.

501.14.1 Checking Piston Squish:

- Inserted solder through the spark plug hole pointed at cylinder wall in line with the piston wrist pin.
- Roll piston through top dead center one revolution on both sides of cylinder using a separate piece of solder for each side. Both sides shall be at or greater than the specific engine spec. (See specific engine for spec)
- If squish is found less than minimum spec, the squish will be checked by other Tech Official or Officials up to 3 squish tests total.

501.15 LAD Port Gauge:

The LAD port gauge is used to check the port heights on the inlet, exhaust and transfer ports.

501.15.1 Checking Exhaust Port Height (LAD Tool):

- Remove cylinder head and attach dial indicator to engine.
- Place piston at top dead center and zero dial indicator.
- Insert LAD Port Gauge (exhaust end) into the exhaust port hooking it in the port. Hold gauge tight against the cylinder wall. Roll piston up to make contact with gauge. While holding slight pressure against gauge, check dial indicator reading. This reading shall be at or greater than specified dimension.



2023 USPKS Rule Book

501.15.2 Checking Exhaust Port Height (Light Check):

- Remove cylinder head and attach dial indicator to engine.
- Place piston at top dead center and zero dial indicator.
- Roll piston down to the spec for that engine
- Place light in cylinder or exhaust port
- No visible light shall be seen from the exhaust port or cylinder respectively

501.15.3 Checking Inlet Port Height:

- Remove cylinder head and attach dial indicator to engine.
- Place piston at top dead center and zero dial indicator.
- Insert LAD Port Gauge (inlet end) into the inlet hooking it in the cylinder against the bottom of the inlet track.
- Roll piston down to make contact with gauge with slight pressure, release pressure and check dial indicator reading. This reading shall be at or less than specified dimension.

*** This can be done by removing spark plug and installing the dial indicator with a spark plug adaptor.**

501.15.4 Checking Transfer Port Heights (Blowdown):

- Remove cylinder head and attach dial indicator to engine.
- Insert LAD Port Gauge (exhaust end) into the transfer port hooking it into the port.
- Hold gauge tight against the cylinder wall.
- Roll piston up to make contact with gauge.

- While holding slight pressure against gauge zero dial indicator
- Remove port gauge from transfer port and place in exhaust port hooking it in the port.
- While holding the gauge against cylinder wall, roll piston up to make contact with gauge.
- Hold slight pressure against gauge.
- The dial indicator reading shall be at or greater than specified dimension.

501.16 LAD CC Measuring Plug:

The LAD CC measuring plug is the only cc plug approved by the USPKS for checking cylinder head volume/cc's.

501.16.1 KZ CC Measuring Plug:

The CIK measuring plug must be used.

501.16.2 Cylinder Head Volume/CC Fluid:

Marvel Mystery Oil is the only acceptable fluid for the head volume/cc test.

501.16.3 Burette:

Shall be Grade "A" certified or calibrated glass burette with a Teflon stopcock.



2023 USPKS Rule Book

501.16.4 CC Procedure:

- This test is performed before the combustion area is altered; example head being removed.
- Engine is at or near ambient temperature, agreed to by competitor.
- Fill burette with Marvel Mystery Oil, allow time for air bubbles to escape.
- Fill the stopcock and stem area with fluid.
- Install LAD cc plug and torque to minimum of 90 inch pounds.
- Bring piston up to just before top dead center.
- Engine should be close to level.
- Set level in burette to zero.
- Verify burette is at zero with competitor.
- Remove any residual fluid from tip.
- Add the fluid through the hole in the cc plug stopping at approximately one cc short of specified amount of fluid, wait approximately 30 seconds before adding the rest of specified amount of fluid.
- Verify specified amount of fluid was added to the engine with the competitor.
- Slowly roll piston up to top dead center.
- If fluid rises above the top of the cc plug the engine is out of specification and will be DQ'ed.

*** This test shall be done on the engine as raced, cleaning of the cylinder head or piston is not allowed for this test. This test will be performed one time to get an accurate test, re-testing is not allowed whether it is the Official's mistake or the competitor asks for a re-test. If the Official made a mistake this test is over, competitor will not be DQ'ed for this test and engine tech will continue.**

**** Comer C-51 engine requires a 0.310" washer to be used with the LAD cc plug.**

503 IAME Bambino M1

Rules & Regulations:

- * Note: All measurements are in inches unless otherwise stated.**
- * Homologation Document listed on the USPKS website will be used for anything not listed below.**
- * No external modifications of any type including air scoops or heat retention additions.**

503.1 Engine:

Shall remain stock as manufactured.

503.1.1 Engine Shroud:

Engine shroud may be placed in either direction but must not be altered in any way.

503.1.2 Tape on Engine Shroud:

Placing tape on the engine shroud is not allowed.

503.2 Carburetor:

Tillotson HS-325A Shall be as manufactured. *Bypassing fuel or air to the motor in any way other than as manufactured is illegal.

503.3 Fuel Filter:

Any fuel filter is permitted. If utilized, it must be between the tank and carburetor.

503.4 Air Filter & Cover:

OEM air filter cover shall be used as manufactured.



2023 USPKS Rule Book

503.5 Spark Plug:

Only NGK – BR8EG, BR8EIX, BR9EG, BR9EIX, BR10EG or BR10EIX can be used with the OEM washer in place. If a cylinder head temperature sensor is utilized, the OEM washer may be removed. Commonly used, stock, cylinder head temperature sensors may be used for comparison.

503.5.1 Spark Plug Boot:

OEM or NGK

503.6 Muffler:

Must use OEM muffler. Excessive leakage in any part of the exhaust system is illegal and competitor could be disqualified. Exhaust Gas Temperature sensors are illegal.

503.6.1 Exhaust Manifold:

OEM exhaust manifold must be in place, 13.5 mm maximum.

503.7 Clutch:

As factory supplied. Maximum drum ID 3.354" (85.2mm). Must be IAME 10 tooth drum without holes. Oiling the clutch is illegal. Must pass clutch test: while on the kart stand competitor will start engine and by holding the brake and applying throttle RPM must not exceed 5000.

503.7.1 Clutch Test Procedure:

- 1) Place kart on secure stand in a safe location
- 2) Verify the axle spins freely
- 3) Start the engine, apply throttle a few times to clear out engine
- 4) Apply full throttle and full brake at the same time without allowing any tire rotation (this may take a couple try's)
- 5) Have someone check your gauge for maximum RPM (cannot exceed 5000 RPM)

503.8 Recoil/External Starter:

Either the recoil or external starter is allowed. Competitor may remove the rope, plastic rope spool and recoil spring if they chose. The two rotating parts on the motor that the recoil engages in must remain in place and the recoil cover must remain in place even if all internal parts are removed.

503.9 Timing Procedure:

- 1) Insert dial indicator in spark plug hole
- 2) Zero at TDC
- 3) Roll piston back to align marks

Per M1 60cc - Pull Start – USA PDF Dated 22/03/2017 (Found on Rt.66 website)

- 4) Reading must be between 0.035" (0.9mm) - 0.059" (1.5mm) before TDC

Note – All ignition parts must be OEM and unaltered.



2023 USPKS Rule Book

504 IAME Swift Rules and Regulations:

- * Must be USA registered engine.
- * Note: All measurements are in inches unless otherwise stated.
- * Homologation Document listed on the USPKS website will be used for anything not listed below.
- * No external modifications of any type including air scoops or heat retention additions.

504.1 Carburetor:

Tillotson HW-31A

Max. Venturi (No Go) 17.15mm

Max Throttle Bore (No Go) 22.10mm

Stock butterfly screw shall be in place

*Bypassing fuel or air to the motor in any way other than as manufactured is illegal.

504.1.1 Carburetor and Manifold Gaskets:

Each of the carburetor and manifold mounting gaskets must be greater than 0.010" in thickness (0.010" No-Go-).

504.1.2 Carburetor Gaskets and

Diaphragms:

The color of the gasket or diaphragm is a non-tech item. Must be OEM and withing the OEM specs.
See 504.11 for specs.

504.2 Fuel Filter:

Any fuel filter is permitted. If utilized, it must be between the tank and carburetor.

504.3 Air Box and Filter:

Blue OEM air box shall be as manufactured, one (1) 23mm tube (No Go). One (1) 0.200" drain hole is allowed. The OEM filter (IAME # 10751-1) must be used. Any external forms of air ducts forcing air inside of air box is illegal. Rain covers are legal during rain conditions as long as it does not act as a ram air device.

* Air filter is not required in competitor's choice or declared rain condition.

504.4 Spark Plug:

Must be as manufactured. Either the OEM spark plug washer, head temp sensor or indexing washer shall be used. Maximum spark plug length of 18.5mm as ran (with washer or temp sensor)

Any of the following plugs may be used:

Autolite AR50, AR51, AR52 or AR53

Denso W#ESZU

NGK B ## EG or BR ## EG

504.4.1 Spark Plug Boot:

OEM part PVL #10544 or NGK #8636 (TB05EMA)

504.5 Bearings, Seals, O-Rings and Gaskets:

May be replaced with aftermarket equivalent unless specified OEM. No ceramic or exotic bearings.

504.5.1 Base Gasket:

Gasket required, changing base gaskets is allowed to obtain exhaust port height. Thickness of the gasket is a non-tech item.

504.5.2 Head Gasket:

Head gasket is **NOT** required but may be used to meet the minimum squish requirement of 0.025" using 0.0625" or 1/16" solder Rule 501.13.



2023 USPKS Rule Book

504.6 Piston and Ring:

Piston and ring shall be OEM as supplied from the manufacturer.

504.7 Mini Swift Exhaust Header:

IAME OEM as supplied. One (1) factory OEM gasket, no spacer or spacers allowed between cylinder and header.

504.7.1 Micro Swift Exhaust Header:

IAME OEM 16mm (0.630") maximum (No Go). Shall have a hole drilled completely through one of the header mounting nuts that will allow the engine seal wire to pass through it. Shall be no leakage at the base of the header.

504.8 Exhaust Pipe:

Shall be OEM as manufactured. Altering internal dimensions or modifications to pipe or silencer end cap is illegal. One hole for exhaust temperature sensor is allowed; if sensor is not used, hole shall be completely plugged. Excessive leakage in any part of the exhaust system is illegal and competitor could be DQ'ed.

504.9 Clutch:

As factory supplied. Maximum drum ID 3.354" (85.2mm). Must be IAME 10 or 11 tooth drum without holes. Oiling clutch is illegal. Must pass clutch test: while on the kart stand competitor will start engine and by holding the brake and applying throttle RPM must not exceed 5000.

504.9.1 Clutch Test Procedure:

- 1) Place kart on secure stand in a safe location
- 2) Verify the axle spins freely
- 3) Start the engine, apply throttle a few times to clear out engine
- 4) Apply full throttle and full brake at the same time without allowing any tire rotation (this may take a couple try's)

- 5) Have someone check your gauge for maximum RPM (cannot exceed 5000 RPM)

504.10 IAME Swift Spec:

Minimum Squish (See Rule 501.13)	0.025"
Minimum Exhaust Port Height (LAD Tool)	1.230"
Minimum Exhaust Port Height (Light Check)	1.095"
Inlet Port Height (LAD Tool)	0.585"
Maximum Bore (42.07mm)	1.656"
Maximum Stroke (43.15mm)	1.699"
Minimum Piston Weight W/Ring	60g
Minimum Piston Pin Weight	15.5g
Piston Pin Length (+ - 0.2mm)	35mm
Piston Pin ID (+ - 0.25mm)	8mm
Piston Pin OD (+ - 0.1mm)	12mm
Complete Crankshaft Minimum Weight	1190g
Minimum Clutch Diameter (83mm)	3.267"
Minimum Clutch Drum No/Driver	182g
Minimum Clutch Weight Type 1	460g
Minimum Clutch Weight Type 2 (10/20)	465g
Micro Swift Header (16mm No-Go)	0.630"

504.11 IAME Swift Tillotson Carburetor HW-31A Spec:

Maximum Venturi (17.15mm No-Go)	0.675"
Maximum Bore (22.10mm No-Go)	0.870"
Carb & Manifold Gaskets (No-Go)	0.010"
Metering diaphragm Gasket	0.016" - 0.024"
Metering diaphragm	0.002" - 0.008"
Fuel Pump Gasket	0.028" - 0.035"
Fuel Pump	0.0015" - 0.006"
Minimum Shutter Thickness	0.030"
Stock/OEM butterfly screw shall be in place.	

2023 USPKS Rule Book

504.12 Sealing the IAME Swift Engine:

IAME Micro Swift:

1st Seal – Two (2) Head Nuts & Two (2) Header Nuts

2nd Seal – Carburetor



IAME Mini Swift:

1st Seal – Two (2) Head Nuts

2nd Seal – Carburetor



- Recommend at least a 5/64" hole in all fasteners.
- Hole and cable must go completely through head of bolt.
- If cable will not go through seal push the cable back and forth a few times to release the lock inside the seal.



2023 USPKS Rule Book

505 IAME KA100 Rules and Regulations:

- * **Must be USA registered engine.**
- * **Note: All measurements are in inches unless otherwise stated.**
- * **Homologation Document listed on the USPKS website will be used for anything not listed below.**
- * **No external modifications of any type including air scoops or heat retention additions.**

505.1 Air Box:

OEM air box shall be as manufactured with two (2) 23mm tube (No Go). One (1) 0.200" drain hole is allowed. The OEM filter (IAME # 10751-1) must be used. Any external forms of air ducts forcing air inside of air box is illegal. Rain covers are legal during rainy conditions as long as it does not act as a ram air device.

- * **Air filter is not required in competitor's choice or declared rain condition.**

505.2 Fuel Filter:

Any fuel filter is permitted. If utilized, it must be between the tank and carburetor.

505.3 Carburetor:

Tillotson HW-33A shall be OEM as manufactured. The carburetor including the finish of the venturi and bore, the arm, throttle shaft, butterfly, slide assembly for jetting and/or manifold shall be OEM and not modified. OEM needle jets are required. Engine and carburetor shall match the specs and carburetor shall be mounted as specified by manufacturer.

- * **Bypassing fuel or air to the motor in any way other than as manufactured is illegal.**

505.3.1 Carburetor Gaskets and Diaphragms:

The color of the gasket or diaphragm is a non-tech item. Must be OEM and within the OEM specs. See 505.18 for specs.

505.4 Reed Cage:

Only OEM fiberglass reeds are allowed with a minimum thickness of 0.012". Reeds must be OEM, sanding, cutting or removal of any material is illegal. Manifold shape and design shall remain as manufactured; grinding or polishing the reed cage or manifold is illegal. Resurfacing the flat rubber contact surface to reeds and gasket surface, de-burring and minor grinding at reed attachment screws is allowed. Reed cage plates shall remain as manufactured and not be altered in any way. Reed screws are non-tech.

505.5 Spark Plug:

Must be as manufactured. Either the OEM spark plug washer, head temp sensor or indexing washer shall be used. Maximum spark plug length of 18.5mm as ran (with washer or temp sensor)

Any of the following plugs may be used:

NGK B10EG, BR10EG, 6254-105, R6252K-105

505.5.1 Spark Plug Boot:

OEM part PVL #10544 or NGK #8636 (TB05EMA)



2023 USPKS Rule Book

505.6 Cylinder Head:

Cylinder head shall be OEM as manufactured; head shall be the same profile as the IAME gauge. Only modification allowed is spark plug thread repair.

505.6.1 Cylinder Head O-Ring or Gasket:

The O-Ring or Head gasket is **NOT** required but may be used to meet the minimum squish requirement of 0.041" using 0.0625" or 1/16" solder Rule 501.13.

505.7 Cylinder:

Ports must remain as manufactured, known stock part may be used as a comparison. Bore and stroke shall be per manufacturer spec and will be taken as raced. Any internal modification such as adding, removing or grinding material is prohibited.

505.7.1 Cylinder Base Gaskets:

Gasket required, changing base gaskets is allowed to obtain exhaust port height. Thickness of the gasket is a non-tech item.

505.8 Bearings, Seals, O-Rings and Gaskets:

May be replaced with aftermarket equivalent unless specified OEM. No ceramic or exotic bearings.

505.9 Crankcase:

Crankcase shall be as manufactured; metal removal or polishing is not allowed except for de-burring and or repair from rod failure. Main bearing pocket repair is allowed provided the pockets are not relocated during the process. Bearings and seals must be OEM as manufactured; replacement bearings shall be a standard bearing with steel or plastic retainers with same width and diameter as stock. Dual-row, ceramic or angular contact bearings are illegal. Seals shall be as manufactured and shall not have the spring removed, trimmed or installed backwards. Any internal modification such as adding,

removing or grinding material is prohibited unless it is for minor repairs as stated above.

505.10 Crankshaft and Rod:

The crankshaft shall be OEM as supplied from the manufacturer; crank shall be the same manufacturer as the motor. Plastic or aluminum crankshaft stuffing supplied by the manufacturer is required. Removing metal, shot peening, polishing or counterweight plugging is illegal. Weights must match that of the supplied specifications. Rod must be OEM as manufactured; removing metal or modifying rod is illegal. Any rod bearing is legal.

505.11 Piston and Ring:

Piston and ring shall be OEM as supplied from the manufacturer.

505.12 Ignition:

Ignition shall be OEM as manufactured. Flywheel key must be in place and not modified.

505.12.1 Ignition Ground Strap:

A secondary ground strap is allowed from one of the ignition bolts to the case.



2023 USPKS Rule Book

505.13 Exhaust Header and Pipe:

Shall be OEM as manufactured; intentional header and pipe modifications are illegal. Interchanging, plating or ceramic-coating is illegal. The system shall be intact at the start and finish of the race as manufacturer intended. One hole for EGT probe is allowed in the header. If probe is not in place hole must be plugged. Must use OEM gasket, only one is permitted (1.3mm minimum thickness). No spacer or spacers allowed between the cylinder and header. Excessive leakage in any part of the exhaust system is illegal and competitor could be DQ'ed,

505.13.1 Junior Exhaust Header

Junior header shall be 22mm (No-Go). Engine seal must go through one of the header nuts.

505.14 Starter & Battery:

Competitor is allowed to remove the starter and battery if they choose. The starter ring gear must remain in place.

505.15 Clutch:

Clutch shall be OEM as manufactured and within factory spec. Oiling clutch is illegal. Clutch cannot be adjustable and must pass clutch test: while on the kart stand competitor will start engine and by holding the brake and applying throttle RPM must not exceed 6000.

505.15.1 Clutch Test Procedure:

- 1) Place kart on secure stand in a safe location
- 2) Verify the axle spins freely
- 3) Start the engine, apply throttle a few times to clear out engine
- 4) Apply full throttle and full brake at the same time without allowing any tire rotation (this may take a couple try's)
- 5) Have someone check your gauge for maximum RPM (cannot exceed 6000 RPM)

505.16 Timing Procedure:

- 1) Insert dial indicator in spark plug hole
- 2) Zero at TDC
- 3) Roll piston back 0.200" before TDC
- 4) Roll piston forward to align timing marks
- 5) Dial indicator must read between 0.080" – 0.106" before TDC

505.17 IAME KA100 Spec:

Minimum Squish (See Rule 501.13)	0.041"
Minimum OEM Reed Thickness	0.012"
Minimum Port Height (LAD Tool)	1.420"
Minimum Port Height (Light Check)	1.295"
Rod Length	102mm
Maximum Stroke	54.05mm
Maximum Bore	48.53mm
Timing (Minimum – Maximum)	0.080" – 0.106"
Minimum Piston Weight W/Ring	95g
Minimum Piston Pin Weight	19g
Piston Pin Length (+ - 0.2mm)	39mm
Piston Pin ID (+ - 0.30mm)	10mm
Piston Pin OD (+ - 0.1mm)	14
Minimum Complete Crank Weight	1820g
Minimum Clutch Diameter (83 mm)	3.267"
Minimum Clutch Weight	375g
Minimum Clutch Drum	225g
Minimum Clutch Drum W/Gear	300g
KA100 Junior Header (No-Go)	22mm

505.18 IAME KA100 Tillotson Carburetor HW-33A

Spec:

Venturi 24.10mm (No-Go)	0.948"
Bore 28.10mm (No-Go)	1.106"
Metering diaphragm Gasket	0.016" - 0.024"
Metering diaphragm	0.002" - 0.008"
Fuel Pump Gasket	0.028" - 0.035"
Fuel Pump	0.0015" - 0.006"
Minimum Shutter Thickness	0.030"

2023 USPKS Rule Book

505.19 Sealing the IAME KA100 Junior Engine:

IAME KA100 Junior:

1st Seal – Two (2) Head Nuts & Two (2) Header Nuts

2nd Seal – Carburetor and two (2) Reed Cage Bolts

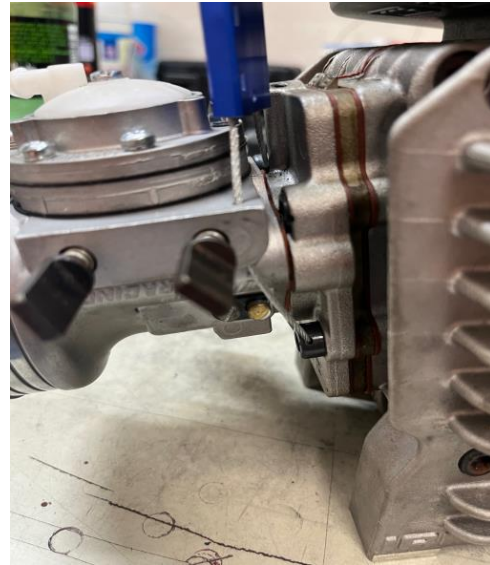

- Recommend at least a 5/64" hole in all fasteners.
- Hole and cable must go completely through head of bolt.
- If cable will not go through seal push the cable back and forth a few times to release the lock inside the seal.

2023 USPKS Rule Book

505.19.1 Sealing the IAME KA100 Senior and Masters Engine:

IAME KA100 Senior and Masters:

1st Seal – Two (2) Head Nuts

2nd Seal – Carburetor and two (2) Reed Cage Bolts



- Recommend at least a 5/64" hole in all fasteners.
- Hole and cable must go completely through head of bolt.
- If cable will not go through seal push the cable back and forth a few times to release the lock inside the seal.



2023 USPKS Rule Book

506 IAME X30 Rules and Regulations:

- * Must be USA registered engine.
- * Note: All measurements are in inches unless otherwise stated.
- * Homologation Document listed on the USPKS website will be used for anything not listed below.
- * No external modifications of any type including air scoops or heat retention additions.

506.1 Air Box:

Must use the new 2021 X30 Air Box (part # 30125740).

Max inside diameter of tubes is 23mm. (0.905" No Go)
The OEM filter (IAME # 10751-1) must be used. One (1) 0.200" drain hole is allowed. In rain condition any rain covers are legal as long as it does not act as a ram air device.

- * Air filter is not required in competitor's choice or declared rain condition.

506.2 Fuel Filter:

Any fuel filter is permitted. If utilized, it must be between the tank and carburetor

506.3 Carburetor:

Shall be OEM as manufactured. The carburetor including the finish of the venturi and bore, the arm, throttle shaft, butterfly, slide assembly for jetting and/or manifold shall be OEM and not modified. OEM needle jets are required. Engine and carburetor shall match the specs and carburetor shall be mounted as specified by manufacturer.

- *Bypassing fuel or air to the motor in any way other than as manufactured is illegal.

506.3.1 Carburetor Gaskets and Diaphragms:

The color of the gasket or diaphragm is a non-tech item. Must be OEM and withing the OEM specs.
See 506.18 for specs.

506.4 Reed Cage:

Only OEM fiberglass reeds are allowed with a minimum thickness of 0.012". Reeds must be OEM, sanding, cutting or removal of any material is illegal. Manifold shape and design shall remain as manufactured; grinding or polishing the reed cage or manifold is illegal. Resurfacing the flat rubber contact surface to reeds and gasket surface, de-burring and minor grinding at reed attachment screws is allowed. Reed cage plates shall remain as manufactured and not be altered in any way. Reed screws are non-tech.

506.5 Spark Plug:

Must be as manufactured. Either the OEM spark plug washer, head temp sensor or indexing washer shall be used. Maximum spark plug length of 18.5mm as ran (with washer or temp sensor)

Any of the following plugs may be used:

NGK R6252K-105 or NGK R6254-105

- * During rain conditions NGK-B10 EG or BR10EG may be used.

506.5.1 Spark Plug Boot:

OEM part PVL #10544 or NGK #8636
(TB05EMA)



2023 USPKS Rule Book

506.6 Cylinder Head:

Cylinder head shall be OEM as manufactured; head shall be the same profile as the IAME gauge.

506.6.1 Cylinder Head Gasket:

Head gasket is **NOT** required but may be used to meet the minimum squish requirement of 0.035" using 0.0625" or 1/16" solder Rule 501.13.

506.7 Cylinder:

Ports must remain as manufactured, known stock part may be used as a comparison. Bore and stroke shall be per manufacturer spec and will be taken as raced + or – 0.008". Any internal modification such as adding, removing or grinding material is prohibited.

506.7.1 Cylinder Base Gasket:

Gasket required, changing base gaskets is allowed to obtain exhaust port height. Thickness of the gasket is a non-tech item.

506.8 Crankcase:

Crankcase shall be as manufactured; metal removal or polishing is not allowed except for de-burring and/or repair from rod failure. Main bearing pocket repair is allowed provided the pockets are not relocated during the process. Bearings and seals must be OEM as manufactured; replacement bearings shall be a standard bearing with steel or plastic retainers with same width and diameter as stock. Dual-row, ceramic or angular contact bearings are illegal. Seals shall be as manufactured and shall not have the spring removed, trimmed or installed backwards. Any internal modification such as adding, removing or grinding material is prohibited unless it is for minor repairs as stated above.

506.9 Crankshaft and Rod:

The crankshaft shall be OEM as supplied from the manufacturer; crank shall be the same manufacturer as the motor. Plastic or aluminum crankshaft stuffing supplied by the manufacturer is required. Removing metal, shot peening, polishing or counterweight plugging is illegal. Weights must match that of the supplied specifications. Rod must be OEM as manufactured; removing metal or modifying rod is illegal. Any rod bearing is legal.

506.10 Piston and Ring:

Piston and ring shall be OEM as supplied from the manufacturer.

506.11 Bearings, Seals, O-Rings and Gaskets:

May be replaced with aftermarket equivalent unless specified OEM. No ceramic or exotic bearings.

2023 USPKS Rule Book

506.12 Ignition:

Ignition shall be OEM as manufactured. Timing shall be the factory setting. Flywheel key must be in place and not modified. System shall be as supplied with control box mounted with factory markings visible for inspection if applicable.

*** Ignition parts shall all match for that ignition.**

506.12.1 Stator:

The stator holes maybe enlarged if needed to adjust the timing but, must be in compliance with 506.12.3 Ignition Timing Procedure



506.12.3 Ignition Timing Procedure:

- 1) Install dial indicator and zero at top dead center (TDC)
- 2) Rotate engine back before TDC at least one (1) revolution of the dial indicator
- 3) Rotate engine back to TDC
- 4) The thin line on the flywheel must land somewhere on the wider molded center line on the stator, or to the right side of this line.

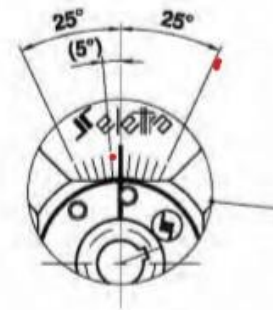

506.12.2 Ignition Rotor & Key:

Ignition key – Open, No Minimum
 Ignition rotor key slot – 0.103" No-Go Maximum
 Must be in compliance with 506.12.3.

506.13 Exhaust Header, and Pipe:

Shall be OEM as manufactured; intentional header and pipe modifications are illegal. Interchanging, plating or ceramic-coating is illegal. The system shall be intact at the start and finish of the race as manufacturer intended. One hole for EGT probe is allowed in the header. If probe is not in place hole must be plugged. Must use OEM gasket, only one is permitted (1.3mm minimum thickness). No spacer or spacers allowed between the cylinder and header. Excessive leakage in any part of the exhaust system is illegal and competitor could be DQ'ed.

506.13.1 Junior Exhaust Header

Junior header shall be 22.7mm (No-Go). Engine seal must go through one of the header nuts.



2023 USPKS Rule Book

506.14 Radiator:

Water system shall have clamps on all hose connections and a radiator catch container for overflow. Thermostats are allowed. Pressurized systems and electric pumps are illegal. Tape may be removed from radiator while on the racing surface.

506.15 Water and Coolants:

Ethylene glycol-based coolants are illegal. Water Wetter or other like surfactants (surface-active agent) can be used.

506.16 Clutch:

Clutch shall be OEM as manufactured and within factory spec. Oiling clutch is illegal. Clutch cannot be adjustable and must pass clutch test: while on the kart stand competitor will start engine and by holding the brake and applying throttle RPM must not exceed 6000.

506.16.1 Clutch Test Procedure:

- 1) Place kart on secure stand in a safe location
- 2) Verify the axle spins freely
- 3) Start the engine, apply throttle a few times to clear out engine
- 4) Apply full throttle and full brake at the same time without allowing any tire rotation (this may take a couple try's)
- 5) Have someone check your gauge for maximum RPM (cannot exceed 6000 RPM)

506.17 IAME X30 Spec:

Minimum Squish (See Rule 501.13)	0.035"
Minimum OEM Reed Thickness	0.012"
Timing	Fixed
Minimum Port Height (LAD Tool)	1.340"
Minimum Port Height (Light Check)	1.215"
Rod Length	102mm
Maximum Stroke	54mm
Maximum Bore	54.35mm
Piston Type – Single Dykes Ring	
Minimum Piston Weight W/Ring	128g
Minimum Piston Pin Weight	28g
Piston Pin ID (+ - 0.25mm)	9mm
Piston Pin OD (+ - 0.1mm)	14mm
Minimum Balance Shaft Weight	315g
Minimum Complete Crank Weight	2150g
Min. Complete Crank with Bearings	2220g
Minimum Clutch Diameter (83mm)	3.267"
Minimum Clutch Weight	375g
Minimum Clutch Drum	225g
Minimum Clutch Drum W/Gear	300g
Min. Clutch with Starter Gear	680g
Minimum Flex Length	17"
X30 Junior Header (No-Go)	22.7mm

506.18 IAME X30 Tillotson HW-27A Carburetor

Spec:

Venturi 27.05mm (No-Go)	1.0649"
Bore 29.10mm (No-Go)	1.146"
Metering diaphragm Gasket	0.016" - 0.024"
Metering diaphragm	0.002" - 0.008"
Fuel Pump Gasket	0.028" - 0.035"
Fuel Pump	0.0015" - 0.006"
Minimum Shutter Thickness	0.030"

2023 USPKS Rule Book

506.19 Sealing the IAME X30 Junior Pro Engine:

IAME X30 Junior Pro:

1st Seal – Two (2) Head Nuts

2nd Seal – Carburetor and two (2) Reed Cage Bolts

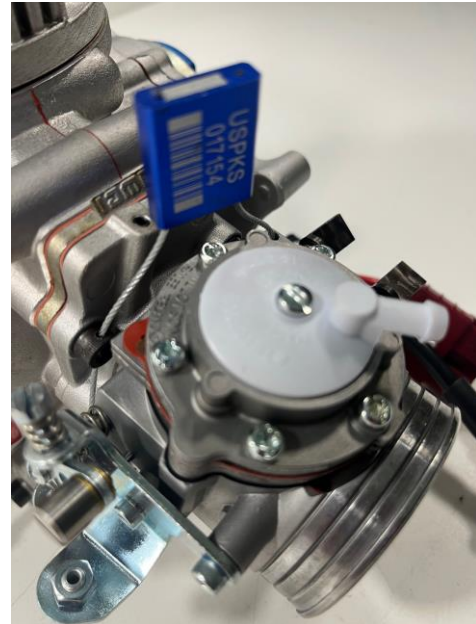

- Recommend at least a 5/64" hole in all fasteners.
- Hole and cable must go completely through head of bolt.
- If cable will not go through seal push the cable back and forth a few times to release the lock inside the seal.

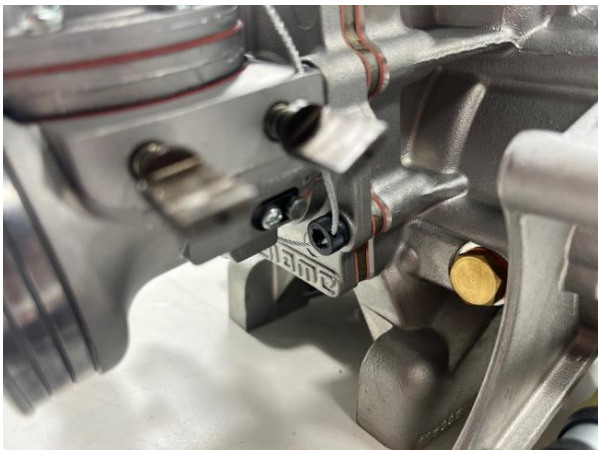

2023 USPKS Rule Book

506.19.1 Sealing the IAME X30 Senior Pro Engine:

IAME X30 Senior Pro:

1st Seal – Two (2) Head Nuts

2nd Seal – Carburetor and two (2) Reed Cage Bolts

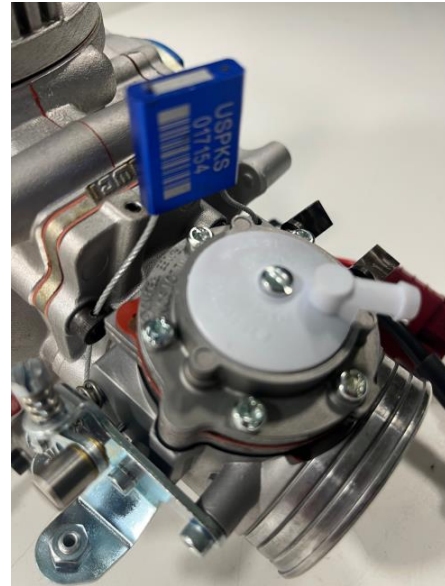

- Recommend at least a 5/64" hole in all fasteners.
- Hole and cable must go completely through head of bolt.
- If cable will not go through seal push the cable back and forth a few times to release the lock inside the seal.

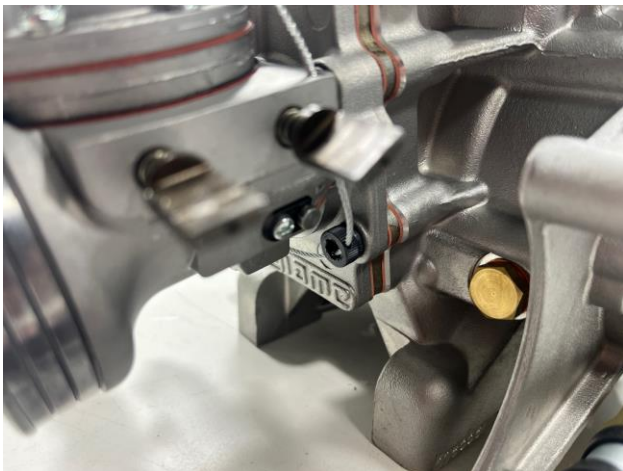



2023 USPKS Rule Book

507 ~~IAME SSE & KZ Rules~~ And Regulations

~~* SSE engine will follow the IAME PDF listed on the USPKS Website.~~

507.1 Homologation:

KZ engine All KZ engines must be homologated by the CIK-FIA. A HF is issued after a homologation inspection and must be supplied with the engine. Engine homologation takes place every three years. The original parts of the homologated engine must always correspond to the photographs, drawings, materials and physical dimensions described in the HF.

507.2 Basic Engine:

Engine characteristics Water-cooled 125 cm³ single-cylinder engine with a reed-valve intake and a gearbox, with one cooling circuit for the crankcase, cylinder and head. It must not be possible to separate the gearbox from the engine. The engine case must be made of two parts (vertical or horizontal). Exhaust port angle limited to maximum 199 °, measured at the level of the port edge in accordance with the method described in Appendix 3. Volume of the combustion chamber: 11 cm³ minimum, measured in accordance with the method described in Appendix 2. Reed-valve cover: free. Gearbox including the primary gear homologated with the engine. To control the ratios, see Appendix 1. Hand-operated mechanical gearbox control.

507.3 Modifications:

Modifications All modifications to the inside of the homologated engine are allowed, except: - the stroke; - the bore (outside the maximum limits); - the connecting rod centerline; - the number of transfer ducts and inlet ports in the cylinder and crankcase; - the number of exhaust ports and ducts; - the reed-valve box (dimensions

and drawing); and - additions to increase the crankshaft diameter; and - inserts in the crankcase and/or cylinder, except those for crankshaft bearings and fixing elements (drilled holes, dowels). All modifications to the outside of the homologated engine are allowed, except: - the number of carburetors; and - the external appearance of the fitted engine. The following are not considered to be modifications to the appearance of the engine: trimming of the cooling connections, modification of the color of the parts and modification of the attachments (including but not limited to those of the carburetor, ignition coil, exhaust, clutch or engine itself) provided that their homologated position is not modified.

507.4 Carburetor:

KZ carburetor Venturi type diffuser carburetor made of aluminum, with a maximum diameter of 30 mm. The carburetor must remain strictly original. The only settings allowed may be made to the slide, needle, floaters, float chamber, needle shaft (spray), jets and needle kit, subject to all the interchanged parts being original. The incorporated petrol filter and plate (part n° 28 on TD n° 2.5 appended) may be removed; if they are kept, they must be original. A fuel tap may be used after the carburetor to adjust the fuel flow. Trophies, a single carburetor supplier is designated following an invitation to tender.

507.5 Silencer/Air Box:

KZ intake silencer They must have ducts with a 30 mm maximum diameter.

507.6 Ignition:

KZ ignition system It must be of the analogue type, without any variable timing system (timing of advance and delay). A mass may be added to the ignition rotor. It must be securely attached by at least two screws, without any modifications to the homologated rotor



2023 USPKS Rule Book

507.7 Exhaust:

KZ exhaust All KZ engines must be fitted with the exhaust homologated with the engine and described in the HF.

507.8 Exhaust Silencer:

KZ exhaust silencer Use of a CIK-FIA homologated exhaust silencer is mandatory. Fitting of the exhaust and silencer must be done according to TD n° 2.7.

507.9 KZ Spec:

Dellorto Carb VSH30	30mm No-Go	1.181"
CC's	13cc W/CIK Plug	
Exhaust Timing	199 max	

507.10 Sealing:

Engine seals/decals will be handed out and placed on the crankcase and cylinder by USPKS Official or competitor in front of an Official.

507.11 Radiator:

Water system shall have clamps on all hose connections and a radiator catch container for overflow. Thermostats are allowed. Pressurized systems and electric pumps are illegal. Tape may be removed from radiator while on the racing surface.